

ANEXO D – DADOS DO SISTEMA DE TECNOLOGIA INOVADORA

L650 - F - 500



NOFI Document name / Dokumentnavn:

NOFI Current Buster® 6 Pat.

DATASHEET (see also drawing L650-A-102)

B	02.01.12	Updated with weight and storage volume			
A	20.05.11	Preliminary. For information only.	øw	dn	dn
Revision	Date (d,m,y)	Issued for	By	Checked	Approved
Revision	Dato (d,m,å)	Utgitt for	Av	Sjekkset	Godkjent

TECHNICAL DATA

Dimensions:	Freeboard: Separator tank: Ø 1000/800mm, guide booms: Ø 800/600mm Length: 62,9m Width: 4,6m Maximum Depth during operation: Ca. 2,6m
Storage weight (dry):	Total: 2017kg. Sweep and guide booms: 872 kg Separator: 1145 kg
Storage volume on boom reel:	Min. 10m ³
Front Opening(Swath):	34m
Separator tank:	Gross volume 65m ³ , Net ca. 35m ³ oil. Separation system is based on gravity separation. In large spills the oil thickness will be min. 1m.
Flotation/cross beams:	33 independent air chambers and 6 air filled cross beams with valve type MONSUN XII.2.
All external fabric :	Heavy Duty PU/PVC-coated polyester, 1150g/m ² , tensile strength 7400 N/50mm, tear strength min.1900 N.
Material buoyancy chambers:	Airtight PU/PVC blend coated polyester, 1150g/m ²
Mooring and lifting points:	8 off, evenly distributed around the system.
Retrieval line at the stern:	4 fastening points, split link connection to the retrieval line.
Reflective markings:	50x200mm reflective pads distributed around the system. On the in and outside.
Documentation:	Complete user documentation, L650-K-610

OPERATIONAL DATA

Area of use:	Offshore and open coast up to Beaufort 5. Protected inlets, fjords, sounds and harbours in extreme weather up to wind Beaufort 7. Also any strong current exposed area with sufficient depth.
Oil types:	All types from diesel to high viscosity oil, ca. 5 – 180000cPS.
Towing /operational speed:	Effective collecting, concentrating and separating oil: Min. towing speed: 0,1-0,5 knots, Calm water: 5 knots, When towing directly against short period waves the max. speed gradually decrease when wave height increase.
Debris collection system:	Prevents debris from entering the Pumping area.
Temporary Oil storage:	The integrated non return valve enables the separator tank to be used for temporary storage of recovered oil. HOLD for verification.
Inflation:	By backpack blower or electric/hydraulic fan through Monsun XII.2 valves
Deployment:	Deployment with guidebooms or separator tank first. An area with minimum width of 5m and length of 5m is recommended in front of the boom reel. Deployment time from reel ca. 25 minutes if two fans are available.
Retrieval:	The NCB6 can be retrieved with guidebooms or separator tank first. Retrieval time ca. 30 minutes.
Adjustments during operation:	The system is designed for operation without any adjustments required even if the speed and oil types vary.
Skimmer Interface:	Within the operational limits, the oil thickness in the separator is high with no current or vortex. Almost all types of skimmers and pumps may be used efficiently in the separator with low water content of recovered oil.
Storage:	On boomreel with shaft diameter of minimum 500mm. Turntable recommended for easier retrieval.
Storage and operating temp.:	-35 to +70°C (-13 to 158 °F)



Document Name / Dokumentnavn:
NOFI Current Buster^y 6 Pat.
User's manual

NOFI Document no. / Dokumentnr.:

L650 - M - 640

A	02.04.12	Comments			
Revision Revisjon	Date (d,m,y) Dato (d,m,å)	Issued for Utgitt for	By Av	Checked Sjekket	Approved Godkjent

TABLE OF CONTENTS

0 GENERAL	3
1 SYSTEM DESCRIPTION	3
General	3
NOFI Current Buster 6.....	4
High speed Otter ^{Pat.Pend} Guidebooms	4
Sweep	4
Collector area	4
Tapered Channel Skimming Device	5
Separator and storage tank	5
Water Drainage Valves.....	5
Towlines and retrieval line	5
CONSTRUCTION	6
Outer fabric	6
Air Chambers.....	6
Crossbeams	7
Debris collection and wave dampening system	7
Wave dampening feature and splash over protection in the stern	7
Transportation and decon detachment and assembly point (TDDAP)	8
Oil stopping Device.....	8
Tie off loops	8
Retrieval bridle.....	8
Valves	8
Reflective areas	8
Highlighted areas.....	9
Pump area	9
2 STORAGE, DEPLOYMENT AND RETRIEVAL	10
Storage	10
Deployment	10
Inflation	10
RETRIEVAL	11
Retrieving with Guidebooms first	11
Retrieving with Separator tank first	11
3 OPERATION	12
Two boats towing, one boat pumping	12
Tow forces	12
Filling the Separator tank	12
Adjustment	13
Maximum towing speed	13
Towing backwards is not recommended	13
Transportation speed	13
Type of oil	13
Re-inflation of air chambers	13
Pumps and skimmers	14
Pumping and offloading recovered oil	14
Turning the Current Buster system	15
Removal of debris	15
Towing configuration	16
Small Spills	16

0 GENERAL

This manual describes the use of the **NOFI Current Buster^y 6^{Pat.}**.

The **NOFI Current Buster 6 (NCB6)** is the latest product based on the **CURRENT BUSTER TECHNOLOGY**. Some of the pictures in this manual show other NOFI Current Buster systems.

All fabrics are vulnerable to damage when dragged over sharp edges, rough concrete and asphalt etc. Such surfaces and sharp edges must be covered with tarpaulin or similar.

After use in oil the equipment should be cleaned as soon as possible, see General Cleaning Procedure for oil booms and PVC/PU fabrics, doc. no. **F000-N-680**, and NOFI Current Buster Cleaning Guide, doc. no. **L600-N-682**.

NOTE: The **NOFI Current Buster^y 6^{Pat.}** is a contingency boom and is not designed for permanent anchoring.

During outdoor storage the equipment must be covered with a tarpaulin to avoid damage from sunlight. If stored in a closed container etc. proper ventilation should be provided to prevent growth of micro-organisms.

SAFETY : Any boom handling and especially high speed operations involve heavy forces and impose a safety risk. In order to avoid personnel injuries, sound seamanship should be practised in all operations. Local safety regulations and practice must be followed.

1 SYSTEM DESCRIPTION

General

The **NOFI Current Buster^y 6^{Pat.}** is designed to collect, separate and contain oil at speeds ranging from 0,5 up to 5 knots in reasonable weather conditions.

Results from testing the NOFI Current Buster 4, in OHMSETT test tank, indicate that the system will normally contain 65% to 98% of the oil, depending on speed, type of oil and wave conditions. The system is generally delivered with toelines and retrieval line. Guidebooms and sweep are integrated in the **NOFI Current Buster 6** system. For more information, see Data Sheet, doc. no. **L650-F-500**.

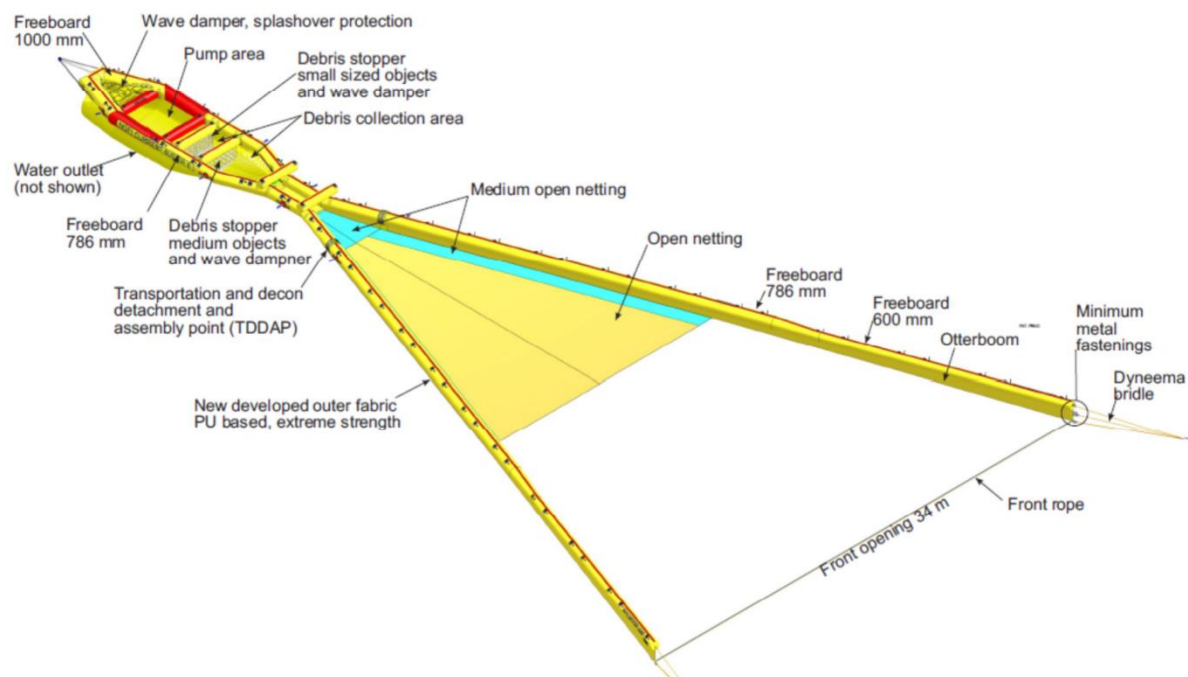

Fig. 1: NOFI Current Buster^y 6^{Pat.}

NOFI Current Buster 6

The **NOFI Current Buster 6** system is supplied as a complete unit, and consists of 5 main parts:

1. High speed Otter^{Pat.Pend} guideboom
2. Sweep
3. Collector area
4. Tapered channel skimming device
5. Separator and storage tank

See drawing no. **L650-A-104** for details and dimensions.



Fig. 2: NOFI Current Buster 6 at ca. 4 knot towing speed

High speed Otter^{Pat.Pend} Guidebooms

The integrated Otter guidebooms are optimised to give a larger front opening compared to a conventional oil boom.

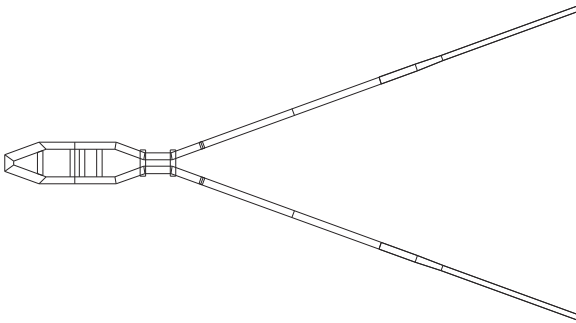

Fig. 3: Integrated high speed Otter^{Pat.Pend} guideboom

Sweep

The integrated Sweep is based on **NOFI VEE-SWEEP[®]** technology, with open apex.

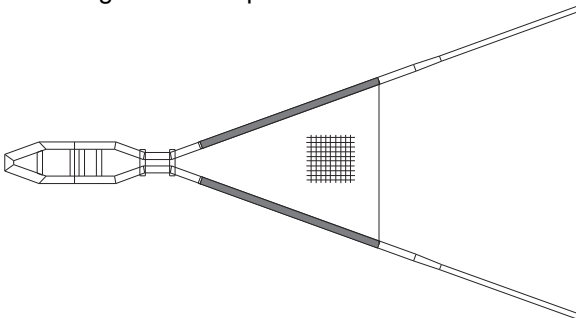

Fig. 4: Integrated sweep

Collector area

The collector area is located at the stern part of the "V"-shaped sweep. The main purpose of the collector area is to create optimal flow conditions into the tapered channel skimming device.

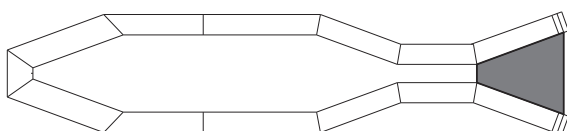

Fig. 5: Position of the collector area

Tapered Channel Skimming Device

The main purpose of the Tapered Channel Skimming Device is to lift the upper layer of the water containing the oil into the separator, while draining most of the surplus water under the system.

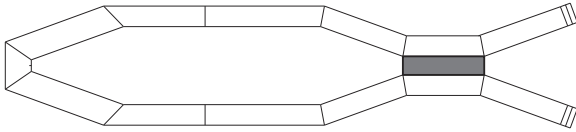

Fig. 6: Position of the tapered channel skimming device

Separator and storage tank

The oil and water mixture entering the separator is separated by gravity separation (settling). The large volume of the separator ensures sufficient separation time so the oil is effectively separated from the seawater. Surplus water is drained through valves in the bottom of the separator. During operation, even at high speeds, the oil is calm in a thick layer inside the separator, and consequently optimal pumping conditions are achieved.

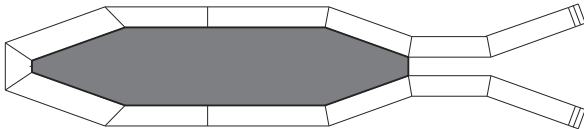

Fig. 7: Position of the separator

Water Drainage Valves

The drainage valves are distributed in the bottom of the separator tank. Overpressure in the separator tank causes the valves to open and let out excess water.

Towlines and retrieval line

Normally two 50 m towlines and two 4 m tow bridles are supplied with the system. Tow bridle and towline can be disconnected.

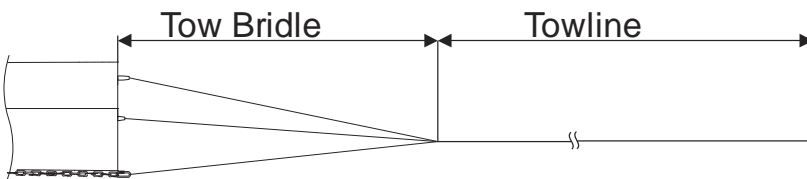

Fig.8: Towline and tow bridle

A retrieval line is connected to the stern of the NOFI Current Buster 6. The line may be connected or disconnected near the stern of the **NOFI Current Buster 6** with a quick link (G-Hook).

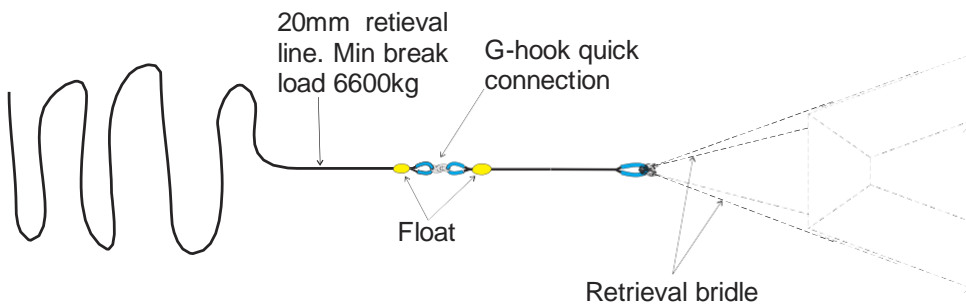

Fig.9: Retrieval line

Construction

The **NOFI Current Buster 6** is made as one unit except the Crossbeams (6 off) and may be divided in two for transportation or decontamination purposes. The system consists of an outer fabric (Jacket) protecting the air chambers.

Outer fabric

The outer fabric is folded over the air chambers and connected on top by plastic eyelets and cleats locked by a plastic-covered rope, which may be disconnected during cleaning when the system is contaminated.

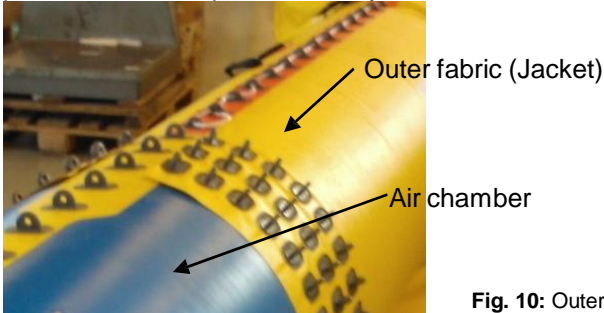

Fig. 10: Outer fabric enclosing the air chambers

All loadbearing functions (mooring points, fastening points for the transverse bladders etc) are handled by the outer fabric

NOTE: If the cleats are deformed by pressure or heat the original shape may be restored with the help of a hot air gun.

Air Chambers

The **NOFI Current Buster 6** has two air chamber systems. There is one in the Guide booms and one in the Separator tank. The air chambers in the Guide booms are 18 individual chambers whereas the air chambers in the separator area are connected to each other forming a frame work, called the Flotation frame.

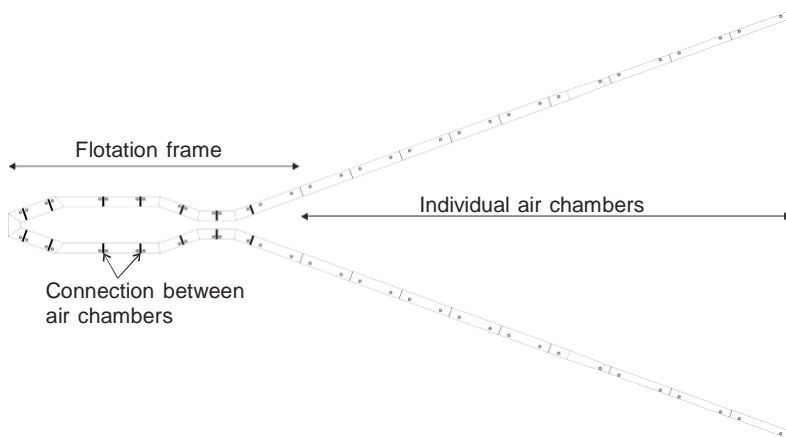

Crossbeams

The air filled Crossbeams add rigidity to the construction. In addition the Crossbeams located at the waterline in the separator have a wave dampening effect, reducing the waves coming into the separator. The Crossbeams may be removed for cleaning etc. and are correctly positioned by number codes on the Crossbeams that correspond with the code on the outer fabric. Note that the fastening straps on Crossbeam no. 1 and 2 are crossed as shown in the picture (see **Fig. 11**)

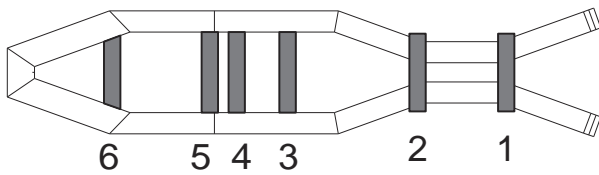

Fig. 11: Crossbeams, 6 off

Fig. 12: Crossbeams with number coding. The crossed fastening straps only applies to Crossbeam 1 and 2.

Debris collection and wave dampening system

In connection with crossbeam no. 3 and no. 4 there are curtains that have the purpose to prevent debris from entering the Pump area. The curtains also act as a wave dampening system that reduces internal movement of oil and water content in the Separator tank.

Wave dampening feature and splash over protection in the stern

The purpose of the perforated fabric in the stern of the Separator and storage tank, see **fig. 13**, is to reduce splash over and reduce wave activity in rough weather conditions and in waves. The device also adds rigidity to the system.

Fig. 13: Splash over protection/wave dampening system in the stern.

Transportation and decon detachment and assembly point (TDDAP)

The connection between the Buster Separator Tank and the integrated sweep and guide boom is a Transportation and decon detachment and assembly point (TDDAP). This includes a connection of the collector area net bottom section to the collector area skirt.



Fig. 14: TDDAP

Oil stopping Device

This device is positioned at the end of the tapered channel towards the stern. During oil collection and operation the device will lay down in open position allowing oil to enter the separator tank. If the NCB6 system for any reason has to stop the device will go into closed position preventing the collected oil to escape.

Tie off loops

Nine tie off loops made in heavy duty webbing and abrasion reinforced fire hose are distributed along the entire NOFI Current Buster 6, see fig. 15.

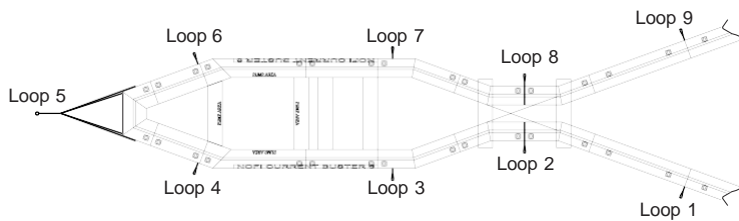

Fig. 15: Tie off loops

The tie off loops indicated on Fig.15 are intended for heavy duty use e.g. towing of other devices, lifting etc.

NOTE: Other potential tie off loops or similar **must not** be used for any fastening, including the closing wire on top of the freeboard or line on the valve lid. *The only exception is fastening of small objects such as radar reflectors or marking lights.*

Retrieval bridle

At the stern of the separator there is a retrieval bridle made of heavy duty webbing and rope. The bridle may be temporarily dropped into the separator if there is any chance of the bridle interfering with propellers on vessels located alongside.

Valves

The air chambers are equipped with valves of type Monsun XII.2 for filling and evacuation of air. All air chambers including the cross beams are equipped with 2 off valves, one in each end. For contamination protection the valve has a screw cap that is secured to the valve with a cord.

Reflective areas

Reflective areas are situated under each valve and opposite area on the inside on the system see, fig. 16.

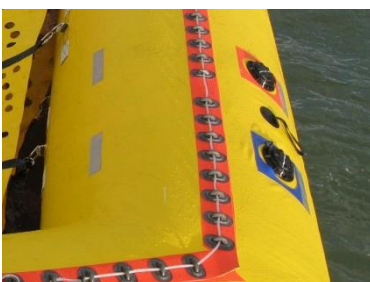

Fig. 16: Reflective area

Highlighted areas

The NCB6 systems have three areas that are highlighted with text. This is information for utility vessels and about areas on the boom that can affect their operation.

The front ends of the Guide booms has text both on the in- and on outside. Outside text states system Starboard and Portside. The inside text, Front rope, states that there is a rope connected between Port and Starboard guide boom. The start of the net section is marked with text and a directional arrow.



Fig. 17: Starboard



Fig. 19: Net section



Fig. 18: Front rope

Pump area

The dedicated area 3 x 3 m set of for pumping and skimming is Orange in contrast to the rest of the system which is Yellow. "Pump Area" is specified in black letters on the orange areas.



Fig. 20: 3 x 3 m Pump area in the Separator

2 STORAGE, DEPLOYMENT AND RETRIEVAL

Storage

The **NOFI Current Buster 6** system can be stored in a custom made storage container, on a pallet or on a boom reel. The inner diameter of the reel should be at least 500 mm in order to avoid damage to the valves.



Fig. 21: NOFI Current Buster 6 stored on a 10m³ boom reel

Deployment

The **NOFI Current Buster 6** is designed for deployment with guidebooms or separator tank first.

An area with minimum width of 5m and length of 5m is recommended in front of the boom reel. Deployment time from reel is approx. 25 minutes if two fans are available.

The integrated Sweep net is weighted and will sink. When deploying in shallow water the net may snag on the bottom. In such unfavourable conditions a rope may be tied around the sweep arms and the netting to prevent the net from sinking. **NOTE:** This rope must be cut or removed prior to operation.

Inflation

Inflation is normally done by a backpack type fan. Electric and hydraulic fans may also be used. To save time, two fans are recommended, one on each side, during deployment.

The air chamber is pressurised to maximum level of a backpack fan, approximately 100 mbar.

CAUTION: The use pressure air for inflation is not recommended due to danger for overpressure and rupture causing personal injury. If for any reason pressure air without pressure gauge is used, the following guidelines may be followed for correct pressure:

At 50-100 mbar a normal person may press a knee 5-10 cm down or a thumb 2-4 cm down in the air chamber, see pictures.



Fig. 22: Testing the overpressure by depressing the air chamber with a knee (left) or a thumb (right).

The Monsun XII.2 valves have an open and a closed position. When the valve seat (plate) is pressed down and turned to the right the valve is locked in open position (as is done during retrieval). When turning to the left the valve is closed. It is still possible to perform inflation with the valve in closed position, since the air pressure presses down the spring activated valve seat, thus letting air in.

SAFETY: If the screw cap isn't attached oil may enter the valve and oil may splash into your face and eyes the next time the valve is opened.



Fig. 23: Monsun XII.2 valve (left) with screw cap (right) shown in open position. The valve seat (plate) in the middle of the valve has been pressed down and turned right.

In order to attain sufficient pressure in the air chambers, inflation must be performed with the valve plate in **closed** position. Let the fan run at full speed until the inflation hose nozzle has been pulled out of the valve. The spring-activated valve closes automatically and no air pressure is lost during opening and closing of the valves.

All air chambers have two valves. The purpose is to make it easy to inflate/deflate the **NOFI Current Buster 6** where the space is limited. **Prior to inflation make sure that the opposite valve is closed.** Corresponding valves have the same colour coding.

Retrieval

The Current Buster 6 system is designed to be retrieved in both directions with separator or guidebooms first.

Retrieving with Guidebooms first

Retrieving with the Guidebooms first has not been tested thoroughly and should be performed with caution. Each user should develop their own strategy for this operation.

IMPORTANT NOTE: When retrieving the **NOFI Current Buster 6** with guidebooms first it takes time before the water in the separator is drained out through the Drainage valves. This must be done gradually, lifting inch by inch, without applying too much force.

Retrieving with Separator tank first

A retrieval line, 50m, is connected to the retrieval bridle by a G-Hook (splitlink) connection (see **Fig. 24**). The line has a minimum breaking load of 6600kg and is the weak-link during retrieval. Retrieval time ca. 30 minutes.

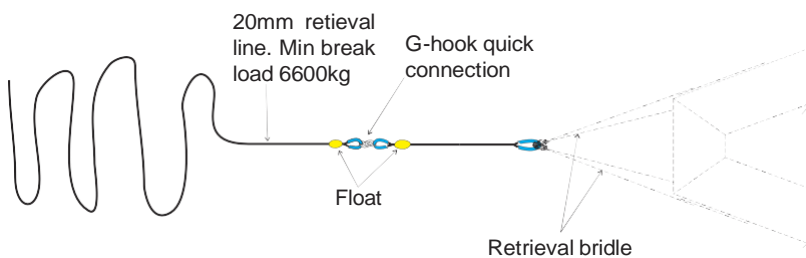

Fig. 24: Retrieval line with G-hooks

IMPORTANT NOTE: When retrieving the **NOFI Current Buster 6** it takes some time before the separator is emptied since the water has to flow over the oil stopping device and through the tapered channel and the narrow water outlet in the separator. This must be done gradually, lifting inch by inch, without applying too much force. In unfavourable conditions water pockets may be formed, requiring manual intervention.

If the system is retrieved to a boom reel, it must be wound up firmly. A vessel or a vehicle may assist in maintaining tension in the system while it is being retrieved. When winding up the towlines, one should make sure that the towlines do not get stuck in between the boom reel's sidewalls and the boom system itself, due to risk of jamming the towlines.

3 OPERATION

The **NOFI Current Buster 6** system is a rather new concept and this manual does not describe optimal operation with all types of vessels/equipment or all modes of operation. Each user should develop their own standard operational procedure based on their own needs.

Single vessel operation

NOFI Current Buster 6 has been tested with a single boat and BoomVane. The test was performed with a standard BoomVane and gave a sweep width of ca. 18m.

Type and size of towboat

The towboats should be of a type that has good directional stability and in other ways are suitable to tow objects.

Two boats towing, one boat pumping

Fig.s 25 and 26 show the system being towed by the help of 2 towboats.

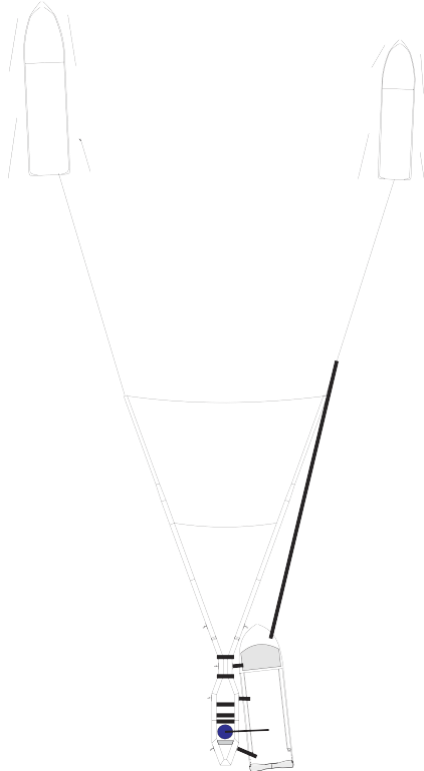

Fig. 25: Two boats tow the system. A skimming vessel is moored alongside the separator while towing.



Fig. 26: NOFI Current Buster 6 in a two boat configuration during testing in Tromsø.

Tow forces

Measurements performed during testing has indicated approximate tow forces:

At 3 knots the tow force was measured to approx. 1,8 tons per vessel, and at 5 knots about 3 tons per vessel.

The values apply for straightforward movement with even speed in calm sea. In case of sudden changes in speed or direction, and in choppy sea, larger tow forces must be expected.

Filling the Separator tank

When the towing starts, the separator will gradually fill with water. An initiate speed of ca. 2,5 - 5 knots is recommended in order to fill up the separator. The filling process takes approx. 10-15 minutes depending on towing speed. During this process the separator bottom may appear unstable but the system will still collect oil.

If the towing stops, ballast in the separator will impede the separator bottom from floating up. However, some water may escape, and when the towing begins again it will take a few minutes to reach the normal filling level.

Adjustment

Even if speed through the water and oil type vary no adjustments of the system are required.

Maximum towing speed

The maximum towing speed is determined in two ways:

- 1) The maximum oil collecting speed is 5 knots through water. Operation at higher speed is not recommended. Note that in current exposed areas a GPS reading will give wrong speed reading against water.
- 2) When towing directly against short-period waves the speed should be limited to 3 knots. When splash over occurs in the stern the speed must be further reduced as contained oil is lost.

Normally higher speeds may be used when towing with the waves or at 90 degrees to the wave direction, compared to directly into the waves, see **Fig. 27**.

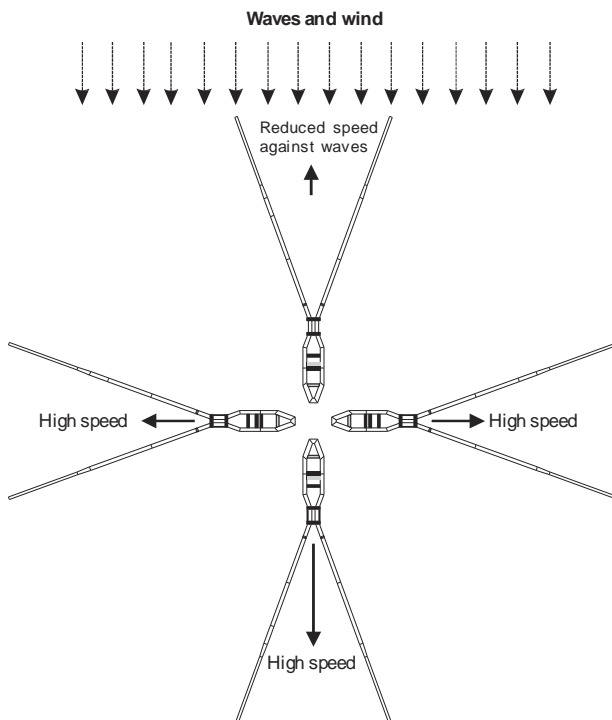

Fig. 27: Towing speed in relation to wind/waves

Towing backwards is not recommended

CAUTION: Towing the system backwards (except during retrieval at very low speed) is not recommended, as the system is not designed for this and will be damaged.

Transportation speed

If the system needs to be transported rapidly from one location to another, actions should be made to decrease the front opening of the system in order to reduce the amount of water entering the system.

This may be done by transferring both towlines to one vessel. Speed through water should still be limited to 6 knots.

Type of oil

The available information from tests conducted with oil indicates that the system can handle most types of oil from low to high viscosities, including diesel oil. Some reports indicate that the system may even be efficient in collecting blue shine.

Re-inflation of air chambers

If there are significant temperature variations (between night and day) or long operating periods the air chambers may require re-inflation if they deflate or deform. This may be done with portable fans.

Pumps and skimmers

The NCB6 system is capable of accumulating up to 1m of oil in the Separator. This should be taken in to consideration when choosing what kind of offloading equipment to be used. Several types of pumps and skimmers may be used for offloading the separator. The pump's or skimmer's outer surface must be free from sharp edges or rotating parts, which may damage the fabric.

Pay attention to the pump and hoses so that no abrasion damage occur e.g. on top of the freeboard. If necessary attach some abrasion protection, tarpaulin etc.



Fig. 28: A skimmer in the separator (Image of NOFI Current Buster 2)

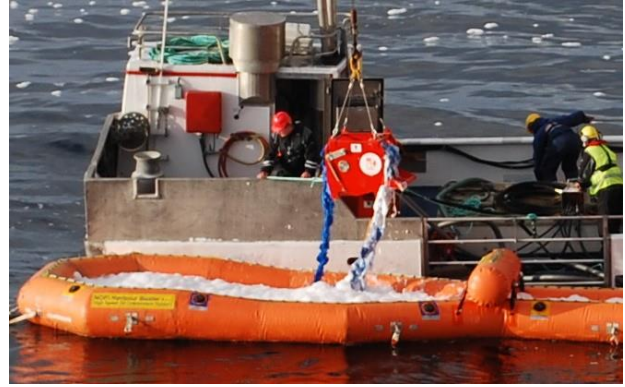

Fig. 29: Rope mop skimmer operating in the separator (Image of NOFI Current Buster 2)

Pumping and offloading recovered oil

The pumping vessel can be moored alongside the separator. In order to avoid damage to the system, the pumping vessel should be of a reasonable size compared to the **NOFI Current Buster 6**, and not have sharp edges or similar facing the system.

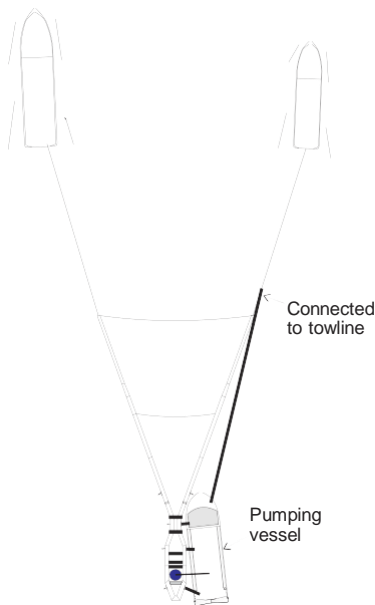

Fig. 30: Pumping vessel moored alongside the separator with mooring lines indicated.



Fig. 31: Mooring line from the bow of the pumping vessel to the connection point between the sweep and the towline. (Image of NOFI Current Buster 4)

Depending on available vessels and utility equipment there are several possible methods and strategies for pumping of the **Current Buster 6**.

SAFETY: Make sure that the pumping vessel does not drift off during high-speed operation leading to the skimmer snagging in the separator.



Fig.32: Excavator with pump offloading a NOFI Current Buster 8 during the Macondo spill in 2010.

Turning the NOFI Current Buster system

If the two towboats are well coordinated, it is a simple task to turn the whole boom system. This can be done with the pumping vessel moored alongside the separator.



Fig. 33: Turning the system at high towing speed (Image of NOFI Current Buster 4)

Removal of debris

Logs, debris and sharp objects may enter the system and cause serious damage. If this occurs, stop the operation and remove the debris.

Floating seaweed, kelp etc. may after a time clog the bottom net in the collector area, create an obstruction in the tapered channel tunnel or clog the outlet of the separator.



Fig. 34: Tapered channel clogged by hawser

If the clogging reduces the performance to an unacceptable level the foreign objects must be removed while the towing is stopped.

Towing configuration

The following information should be handed over to the towboat captains prior to towing:

In order to maintain the correct towing formation when operating the **NOFI Current Buster 6** the following rules should be followed:

- 1) One towboat should lead and the other should follow and make necessary adjustments. Still both the towboats are responsible for keeping the system in a good formation. Agree on who is the leader boat, draw lots if necessary.
- 2) The towlines should have equal lengths and be moored as low as possible on the towboats.
- 3) Both towboats should continuously monitor the boom.
- 4) Start towing at 2,5 knots, the distance between the towboats small, e.g. 15-20 m.
- 5) The towboats should preferably move more or less in parallel.
- 6) The towboats should practice on changes in speed and course.
- 7) Gradually increase the distance between the towboats until correct formation is achieved, see **Fig. 35**.
- 8) If there are continuous problems with misshape of the boom the boats may move closer.
- 9) It is normally easier to keep the configuration of the system at a speed above 2 knots.

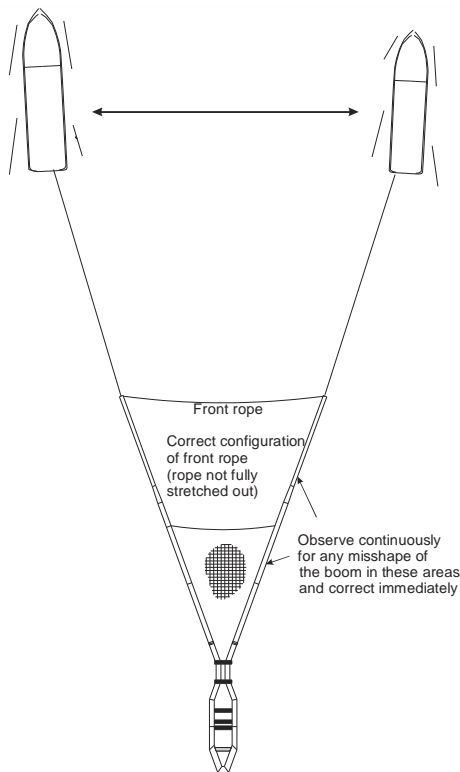

Fig. 35: Correct positioning of towboats.

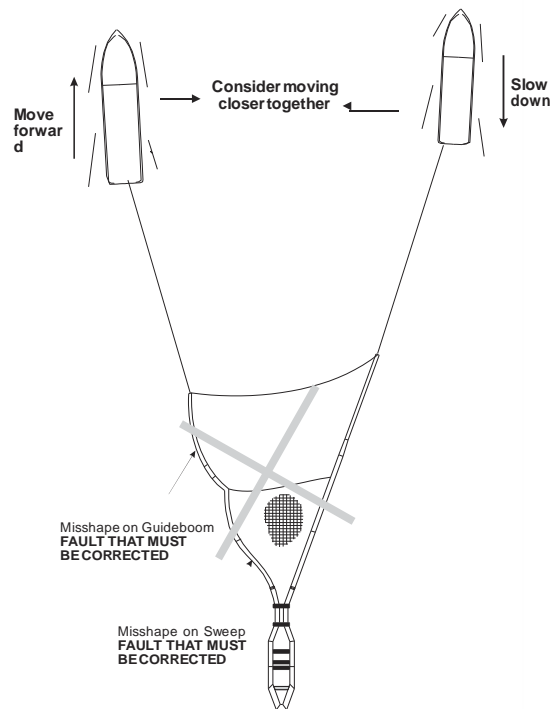

Fig. 36: Incorrect positioning of towboats causing misshape on guide boom and sweep.

Small Spills

If the oil spill is small, i.e. less than the storage capacity of the separator (approx. 30-40 tonnes), two boats may tow the system and the oil may be discharged at the end of the clean-up operation. Alternatively, a pumping vessel may empty the separator as needed.

High Capacity Advancing Oil Recovery System Performance Testing at Ohmsett for the Wendy Schmidt Oil Cleanup X CHALLENGE

Paul Meyer, Bill Schmidt, Dave DeVitis, and Jane-Ellen Delgado
MAR Incorporated/ Ohmsett Test Facility
Atlantic Highlands, NJ, USA
pmeyer@ohmsettnj.com

Abstract

Ohmsett - The National Oil Spill Response Research & Renewable Energy Test Facility was selected as the test venue for the \$1.4 Million Wendy Schmidt Oil Cleanup X CHALLENGE. The competition was designed to inspire a new generation of innovative solutions for recovering spilled oil from the seawater's surface.

Ten finalists, selected from more than 350 entries from around the world, demonstrated oil cleanup systems during rigorous testing where they each had 10 days to demonstrate their individual technology in the Ohmsett test tank. In this head-to-head competition, a \$1 Million Grand Prize was awarded to the team that demonstrated the ability to recover oil from the water's surface at the highest oil recovery rate (ORR) at oil recovery efficiency (ORE) of more than 70%.

This was the largest oil recovery test ever conducted at Ohmsett. This paper discusses the test setup and methodology used during the high capacity advancing oil recovery system performance testing at Ohmsett.

1 Introduction

The X PRIZE Foundation, a non-profit organization, selected Ohmsett as the test venue for the \$1.4 Million Wendy Schmidt Oil Cleanup X CHALLENGE. This challenge, the Foundation's sixth major competition, was designed to inspire a new generation of innovative solutions for recovering spilled oil from the seawater's surface.

The \$1 Million Grand Prize would go to the team with the highest oil recovery rate (ORR) provided the ORR was greater than 9500 liters per minute (L/min) (2500 gallons per minute (gpm)) and the system's recovery efficiency (RE) was greater than 70%. To put this in perspective, prior to the competition the largest capacity skimmer ever tested at Ohmsett achieved an ORR of approximately 3,400 L/min (900 gpm).

The X PRIZE committee determined that the competition should enable contestants to possibly recover 11356.2 L/min (3,000 gal min) of oil or greater. The advancing speed range was decided to be between one and four knots. To enable the contests to encounter that much oil, an 18.3 m (60 ft) swath width was chosen with a minimum tow speed of one knot. Based on the 18.3 m (60 ft) width at one knot tow speed, the required slick thickness was 25 mm (1 in), which equated to 11356.2 L/min (3000 gpm). This allowed contestants to choose a narrower swath width with higher speeds to encounter 11356.2 L/min (3,000 gal min) or greater. Later, the X PRIZE committee decided to reduce capacity to 9500 L/min (2500 gal) to meet performance goals.

Testing was conducted by Ohmsett staff with competition oversight by impartial judges provided by X PRIZE. The judges included personnel from industry and government agencies with oil spill response experience. To guarantee fairness, a judge was present whenever a team was on-site.

The competition took place from July through September 2011. Each team was given ten days at Ohmsett to demonstrate their system, including three full days of testing in the test basin. To ensure that the last team that tested did not have the advantage of additional development time, all team equipment had to be en route to Ohmsett by the same date. Tools and spare parts were required to be in the main shipment and additional parts and/or tools were not allowed to be brought to the facility at a later date.

2 Test Apparatus

2.1 Test Area

Ohmsett's test basin is 203 m long x 20 m wide (667 ft x 65 ft) with three moveable bridges that span the width of the tank. The bridges, mounted on rails that run the length of the tank, can travel at speeds up to 3.1 m/s (6 knots). For this competition, each team's oil recovery system was rigged between the Main Bridge and the Auxiliary Bridge. The team's ancillary equipment, such as hydraulic power units and control stands, were mounted on the Main and/or Auxiliary Bridge.

At the south end of the basin is a wave generator and at the north end is a wave attenuating beach system. Allowing for the wave-generating equipment, beaches, and acceleration and deceleration zones, the teams had approximately a 122-m (400-ft) long test area to operate their system under steady state conditions. The test tank is shown in Figure 1.



Figure 1 Ohmsett Test Tank with a 25 mm (1 inch) oil layer

2.2 Test Oil

Hydrocal 300 was used as the test oil because its properties would remain consistent over the course of testing. The nominal viscosity of Hydrocal is 200 cP at 20.0°C, with specific

gravity of 0.903, and interfacial tension of 20.6 dynes per cm at 25.5°C. The Hydrocal was dyed red for better visibility.

2.3 Slick Thickness

To achieve the nominal slick thickness of 25-mm (1-inch) for the oil recovery systems to encounter the required 102,000 L (27,000 gal), oil was dispensed on the surface of the tank. A VisiScreen device was used to measure and document the slick thicknesses at multiple locations in the test basin prior to each test.

2.4 Oil Distribution and Sampling

76,000 L (20,000 gal) calibrated frac tanks were used to store the 303,000 L (80,000 gal) of test oil. As test oil was transferred from the frac tanks to the test basin, the oil levels in the frac tanks were carefully measured to ensure the proper amount of oil was transferred to create the 25-mm thick (1-inch) slick. As oil was dispensed into the test tank, samples were obtained and analyzed to confirm initial oil properties. Multiple oil surface samples were obtained and analyzed for initial properties prior to each official test.

2.5 Oil Recovery

Two banks of four-cell calibrated recovery tanks, located on Ohmsett's Auxiliary Bridge, were used during the test (Figure 2). Each of the eight recovery tanks had a capacity of approximately 2,300 L (600 gal) and for sounding purposes, equates to 1.8 L/mm (11.8 gal/in). Fluid depth was measured with a 1.2 m (4 ft) aluminum ruler, and readings were accurate to within 3 mm (1/8 in).



Figure 2 Recovery Tanks on the Auxiliary Bridge

The skimmer's discharge line was connected to Ohmsett's manifold system via a 254-mm (10-inch) flange. A wye downstream of the flange split the flow into two 254-mm (10-inch) pipes, and recovered fluid traveled 4.5 m (15 ft) vertically up to a 203-mm (8-inch) 3-way valve located at each recovery tank. Each manually operated 3-way valve either diverted flow to bypass mode or to collect mode. As each skimmer was allowed to reach to steady state conditions, fluid flow was diverted to bypass mode where the fluid traveled through the manifold and returned to the basin surface. Once the timed collection period started, flow was diverted to the recovery tanks. Prior to test end, flow was redirected to bypass and the collection period ended.

The volume of oil recovered was determined in the following manner. At test end, fluid soundings of each recovery tank cell were obtained to determine total volume of fluid recovered. Following a 30-minute period in which gravity separation took place, free water was decanted from the bottom of each recovery tank cell. A second set of fluid soundings were obtained from which the gross oil volume was calculated. The remaining fluid was stirred and a representative sample was obtained and sent to Ohmsett's on-site lab for water content analysis per ASTM D-1796 (ASTM, 2011). After deducting the free and entrained water from the total fluid recovered, the volume of (pure) oil recovered was determined. Valves located at the bottom of each recovery tank cell allowed for visual decanting of free water.

3 Test Procedure

This was an advancing skimmer test and the methodology was developed based on guidelines from ASTM's F-2709, *Standard Test Method for Determining Nameplate Recovery Rate of Stationary Oil Skimmer Systems* (ASTM 2008a) and ASTM F-631, *Standard Guide for Collecting Skimmer Performance Data in Controlled Environments* (ASTM, 2008b).

3.1 Preliminary Tests

The ASTM F-2709 standard suggests a minimum measurement period of 30 seconds (ASTM, 2008a). The minimum 30 second test period would be waived only if the system filled all eight recovery tanks (18,000 L (4800 gallons)) within 30 seconds. Other applicable data collection, measurement and sampling techniques were integrated into the protocol based on ASTM standards.

Prior to official testing, each manufacturer was allowed one day of practice runs to adjust equipment settings and operational speeds to optimize their system and determine the best tow speeds for calm and wave conditions.

3.2 Performance Tests

The measurement period for each test began when:

- The skimmer system was at its proper tow speed;
- The skimming system was adjusted to its optimum setting;
- The oil recovery and discharge flow appeared to be at steady state;
- The team signaled they were ready to begin the measurement period.

When the above conditions were met, the 3-way valve on each bank of recovery tanks was swung to divert the flow from bypass mode to collect mode and timing started.

The test could end in three possible ways: typically the team leader signaled to end the test period; the tanks were full; or the end of the test distance was reached. At test end flow was

redirected to bypass mode and timing ceased. All measurements were taken and the skimmer system was repositioned to start the next test.

3.3 Calculation of Performance Measurements/Oil Recovery Rate and Oil Recovery Efficiency

The two performance measurements are:

Oil Recovery Rate (ORR): Total volume of oil recovered per unit time.

$$\text{ORR} = \frac{V_{\text{oil}}}{t} \quad (1)$$

Where: ORR = Oil Recovery Rate, L/min (gpm)
 V_{oil} = Volume of oil recovered, L (gal) (decanted and lab corrected)
 t = Elapsed time of recovery, minutes

and: Recovery Efficiency (RE): The ratio of the volume of oil recovered to the volume of total fluid recovered.

$$\text{RE} = \frac{V_{\text{oil}}}{V_{\text{total fluid}}} \times 100 \quad (2)$$

Where: RE = Recovery Efficiency, %
 $V_{\text{total fluid}}$ = Volume of total fluid (water and oil) recovered



11 October 2011

Dear Dag,

Congratulations to you and NOFI for completing your testing at Ohmsett during the Wendy Schmidt Oil Cleanup X CHALLENGE this past summer. All of us, including Judge Gene Johnson as well as the personnel at the Ohmsett facility, were pleased to see your system operating in the test basin in pursuit of this X CHALLENGE. Your team spirit and camaraderie were appreciated by all.

In this binder, you will find your team’s test results, associated data, pictures, and video from Ohmsett.

Below, we have included a summary of your team’s mean Oil Recovery Rate (ORR) and mean Oil Recovery Efficiency (ORE) as calculated by the Judging Panel and the X PRIZE Foundation in accordance with the Competition Guidelines and Field Testing Procedures. In addition, we have provided a summary of which of your Official Test Runs were used to compute your official score in the competition.

Combined MEAN ORR	Combined MEAN ORE	CALM MEAN ORR	CALM MEAN ORE	Run 1 CALM Ohmsett #83			Run 2 CALM Ohmsett #84		
				ORR	% from mean	ORE	ORR	% from mean	ORE
2712	83.0	2958	91.9	2865	3.1%	90.1	2553	N/A	71.1
				Run 3 CALM Ohmsett #85			Run 4 CALM Ohmsett #90		
				ORR	% from mean	ORE	ORR	% from mean	ORE
				2860	3.3%	91	3149	6.5%	94.7
		WAVE MEAN ORR	WAVE MEAN ORE	Run 1 WAVE Ohmsett #86			Run 2 WAVE Ohmsett #87		
		ORR		% from mean	ORE	ORR	% from mean	ORE	
		2466	74.0	2573	4.3%	78.5	2419	1.9%	72.3
				Run 3 WAVE Ohmsett #88			Run 4 WAVE Ohmsett #89		
				ORR	% from mean	ORE	ORR	% from mean	ORE
				2399	N/A	72.2	2406	2.4%	71.3

= Official Test Run used for calculation

= Official Test Run not used for calculation

xxx = individual test run results meet or exceed competition criteria

xxx = individual test run results less than competition criteria

Again, congratulations for completing this enormous effort and we wish you all the best in your future endeavors!

Sincerely,

The Wendy Schmidt Oil Cleanup X CHALLENGE Team and the X PRIZE Foundation

