

Seções da Mina do AVISO 2009

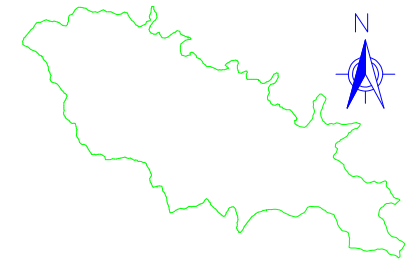

MINA DO AVISO

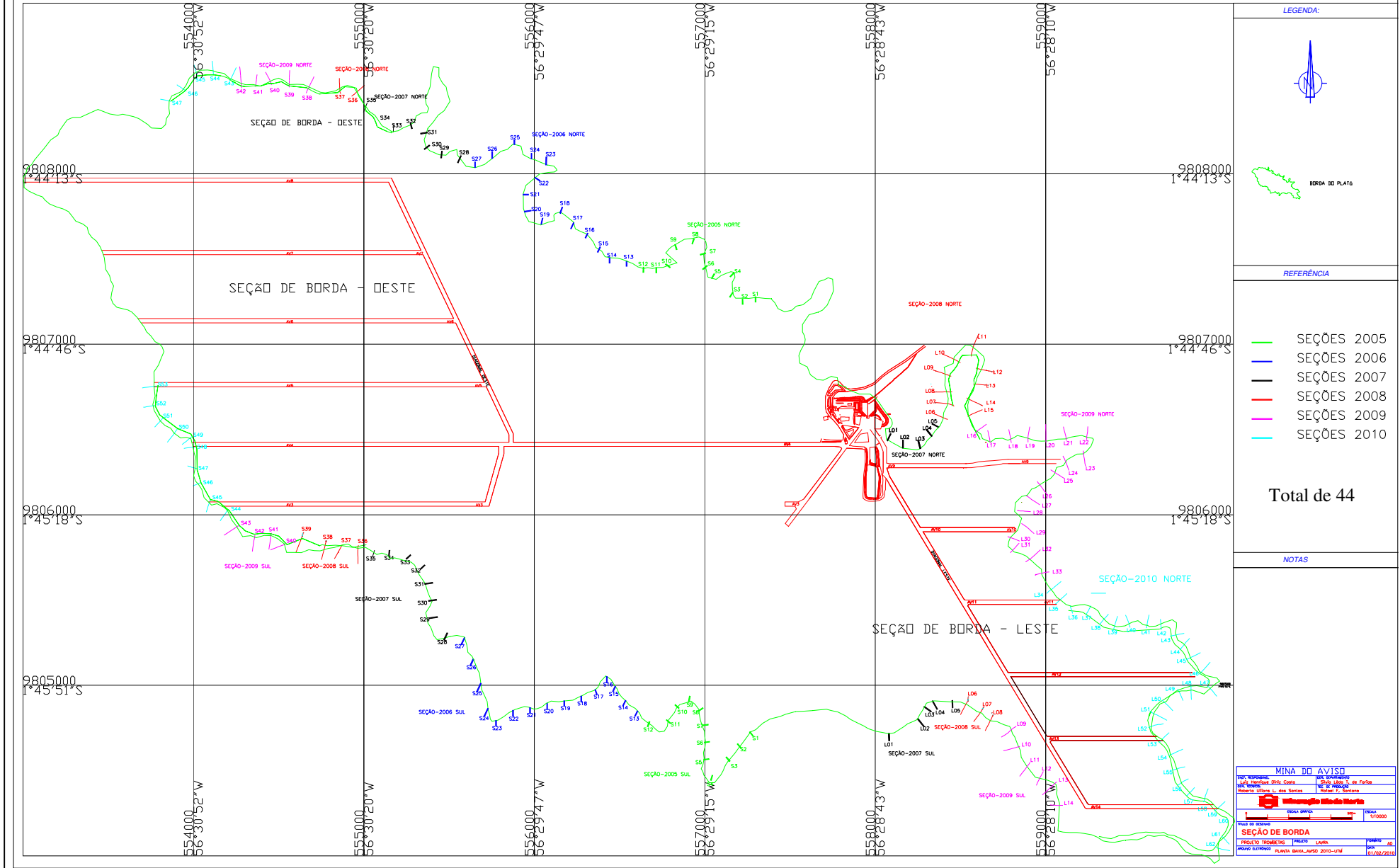

LEGENDA:

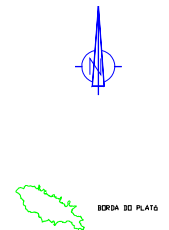

REFERÊNCIA

- SEÇÕES 2005
- SEÇÕES 2006
- SEÇÕES 2007
- SEÇÕES 2008
- SEÇÕES 2009
- SEÇÕES 2010

Total de 44

NOTAS

MINA DO AVISO	
PROJETO: TROMBETA	FOLHA: LAMPA
DATA: 02/09/2010	AUTOR: R. M. SILVA
ELABORADO: R. M. SILVA	REVISOR: R. M. SILVA
APROVADO: R. M. SILVA	

MINA DO AVISO - LESTE

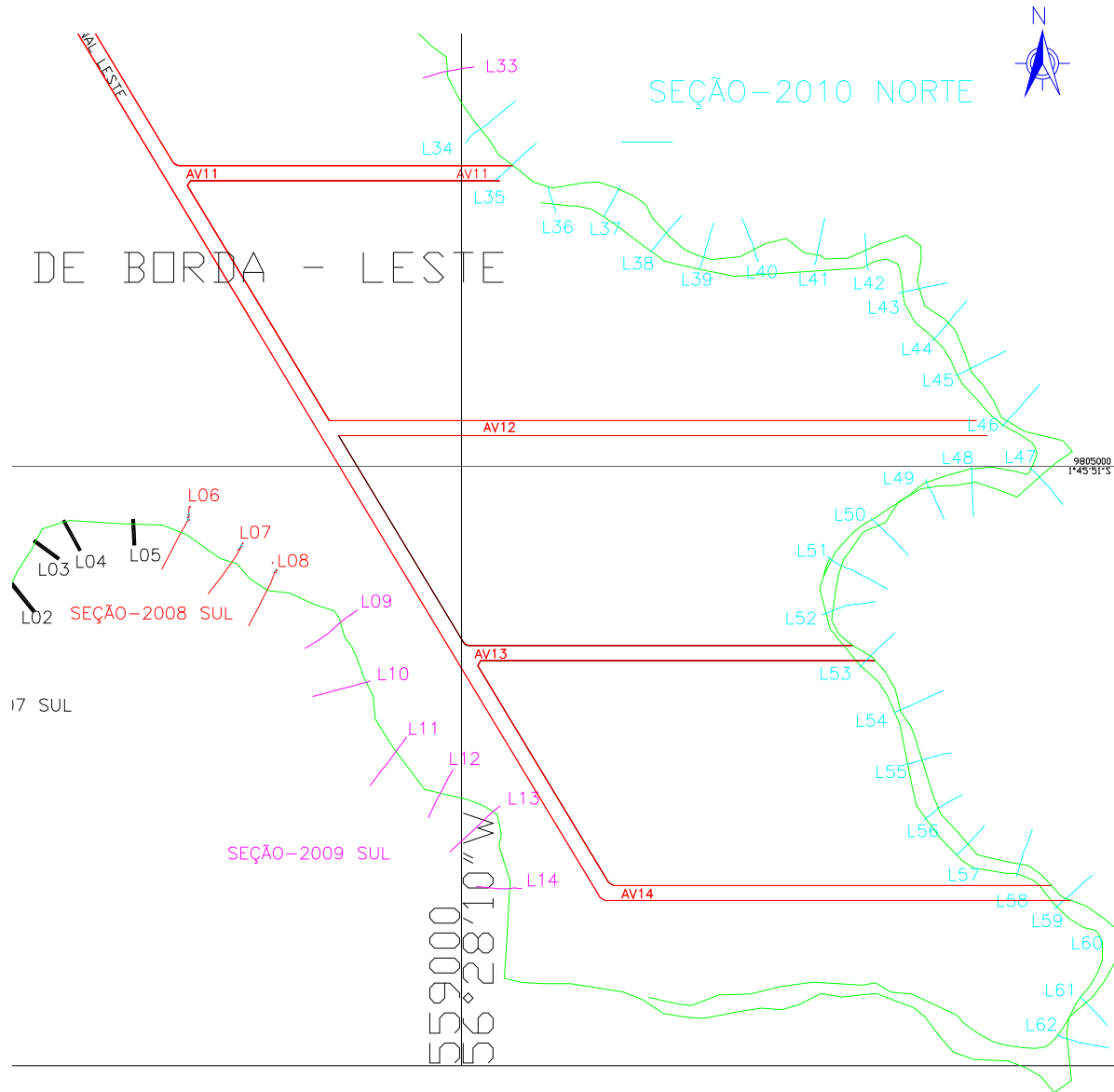

Total de 29



PERFIL LONGITUDINAL SEÇÕES DE BORDAS 2010

Seção L34 AVN

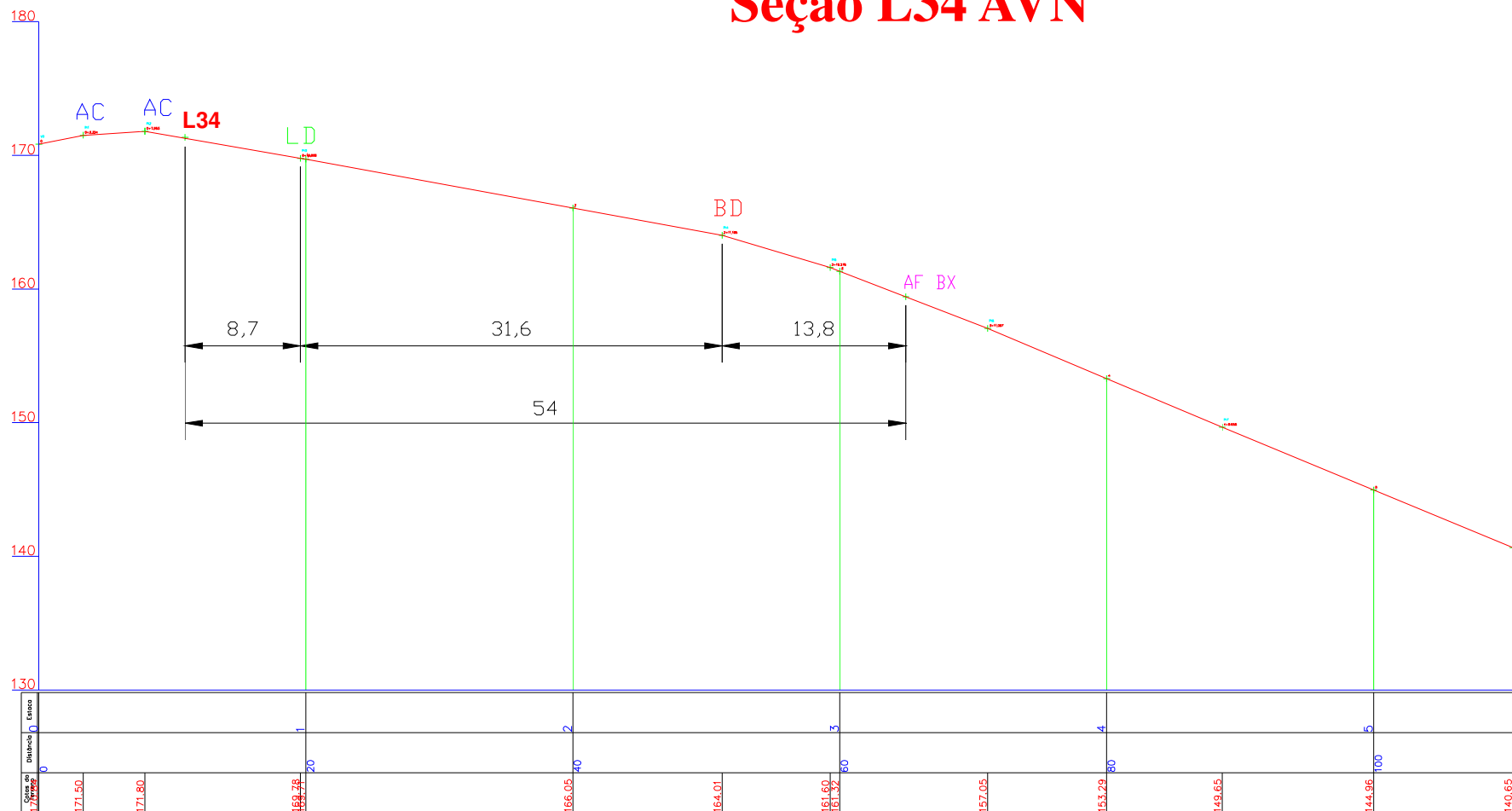

AC - Acesso
LD - Limite de Desmatamento
BD - Borda
AF - Afloramento
BX - Bauxita ND - Nodular
LT - Laterita

ESCALA 1:200 H 1:200 V



PERFIL LONGITUDINAL SEÇÕES DE BORDAS 2010

Seção L35 AVN



- AC - Acesso
- LD - Limite de Desmatamento
- BD - Borda
- AF - Afloramento
- BX - Bauxita ND - Nodular
- LT - Laterita

ESCALA 1:200 H 1:200 V

Seção L36 AVN

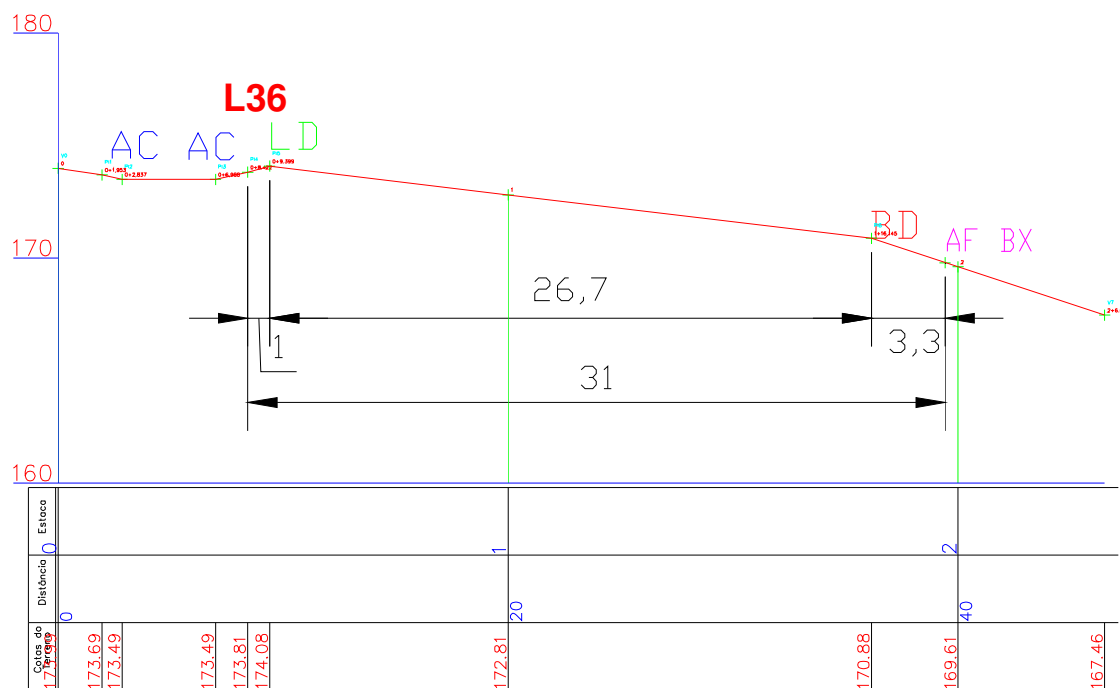

AC - Acesso
 LD - Limite de Desmatamento
 BD - Borda
 AF - Afloramento
 BX - Bauxita ND - Nodular
 LT - Laterita

ESCALA 1:200 H 1:200 V



PERFIL LONGITUDINAL SEÇÕES DE BORDAS 2010

Seção L37 AVN

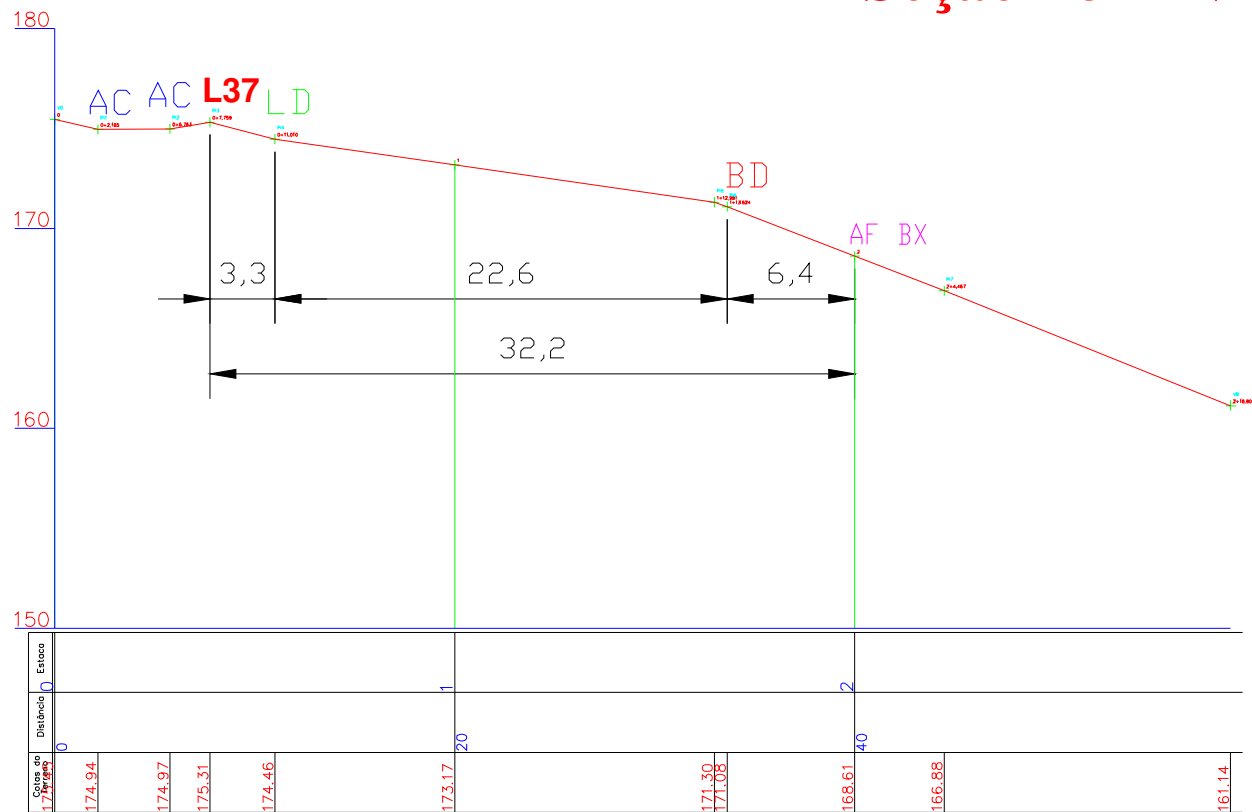

AC - Acesso
LD - Limite de Desmatamento
BD - Borda
AF - Afloramento
BX - Bauxita ND - Nodular
LT - Laterita

ESCALA 1:200 H 1:200 V



PERFIL LONGITUDINAL SEÇÕES DE BORDAS 2010

Seção L38 AVN

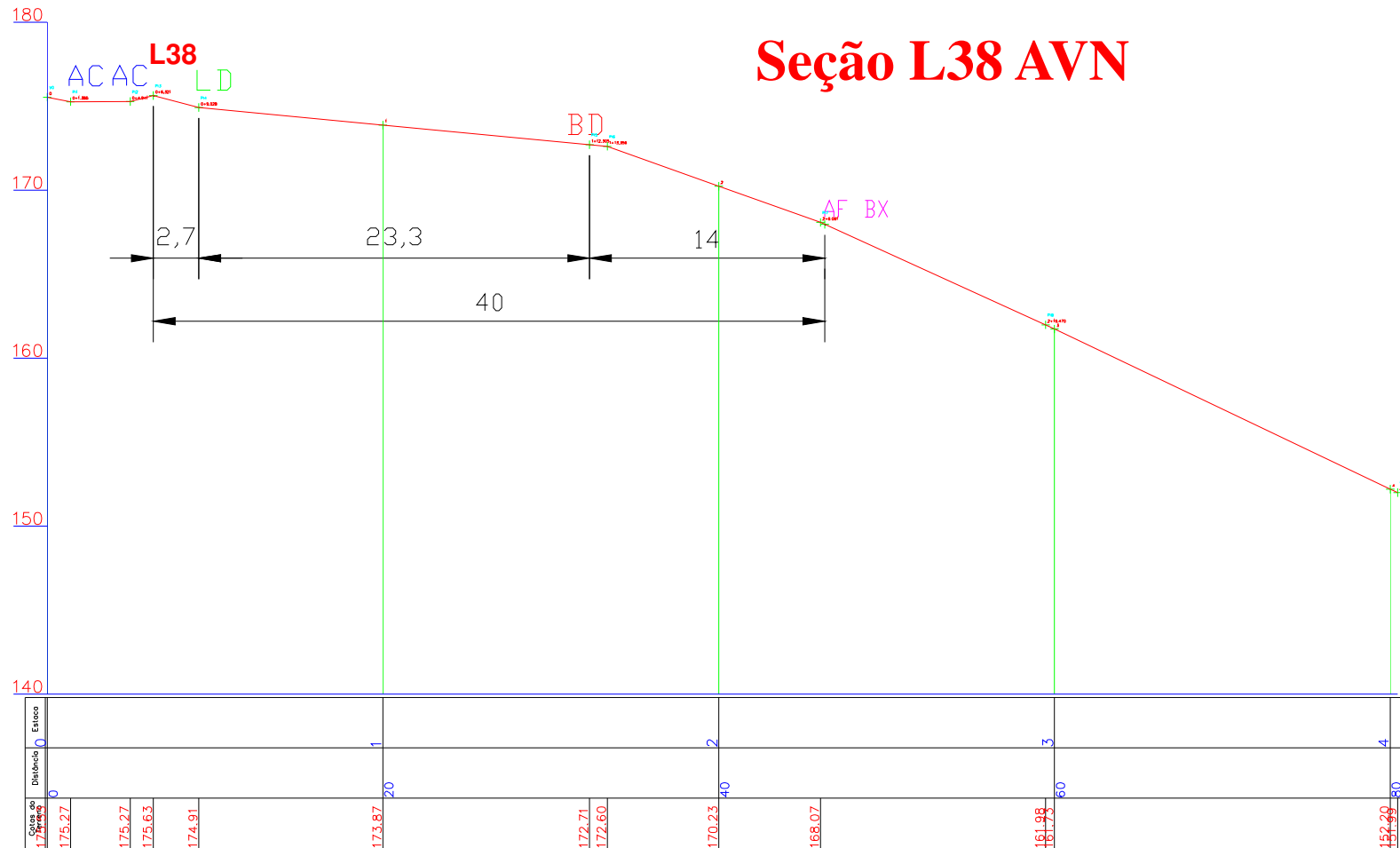

- AC - Acesso
- LD - Limite de Desmatamento
- BD - Borda
- AF - Afloramento
- BX - Bauxita ND - Nodular
- LT - Laterita

ESCALA 1:200 H 1:200 V

Seção L39 AVN

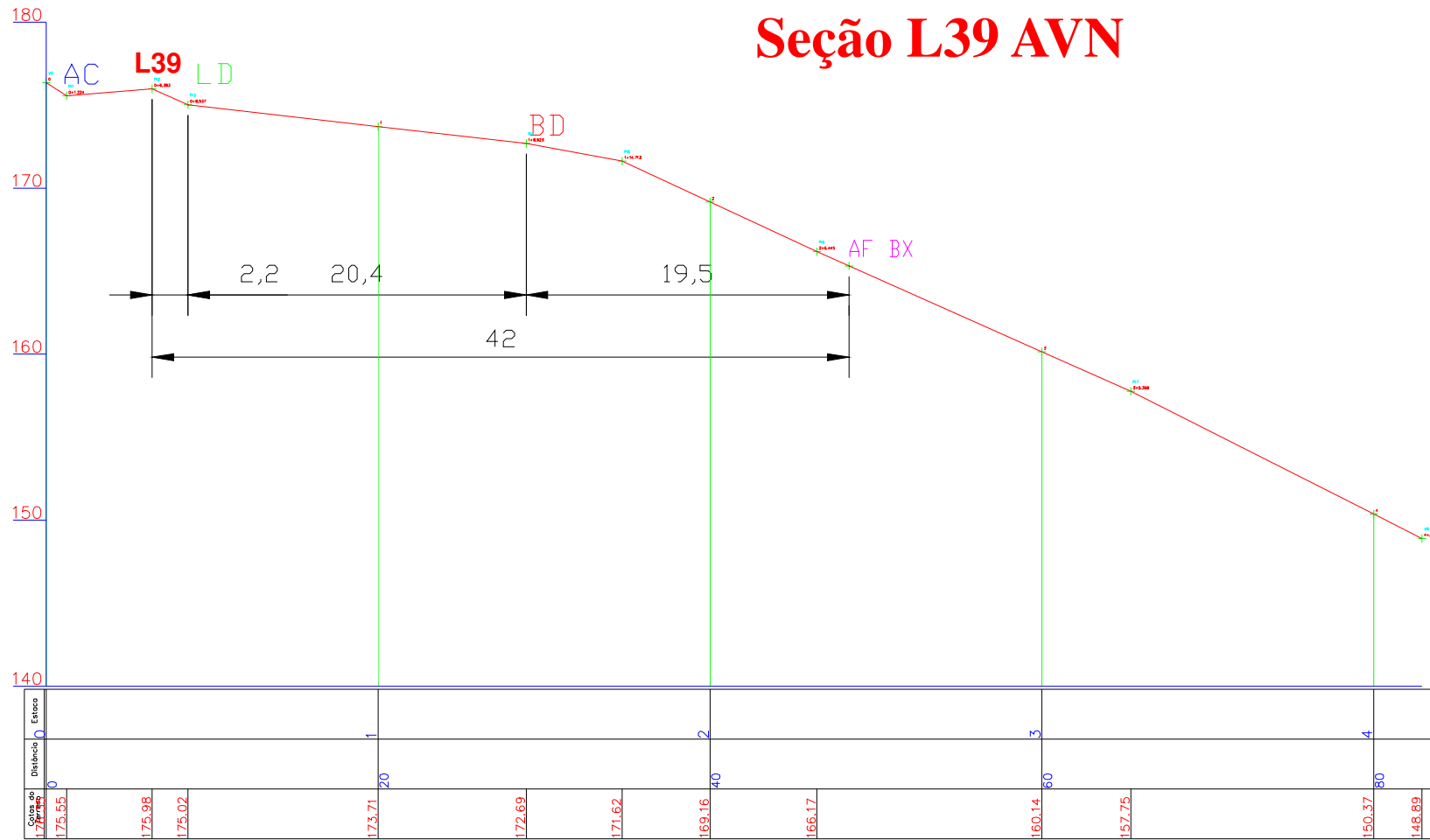

AC - Acesso
 LD - Limite de Desmatamento
 BD - Borda
 AF - Afloramento
 BX - Bauxita ND - Nodular
 LT - Laterita

ESCALA 1:200 H 1:200 V

Seção L40 AVN

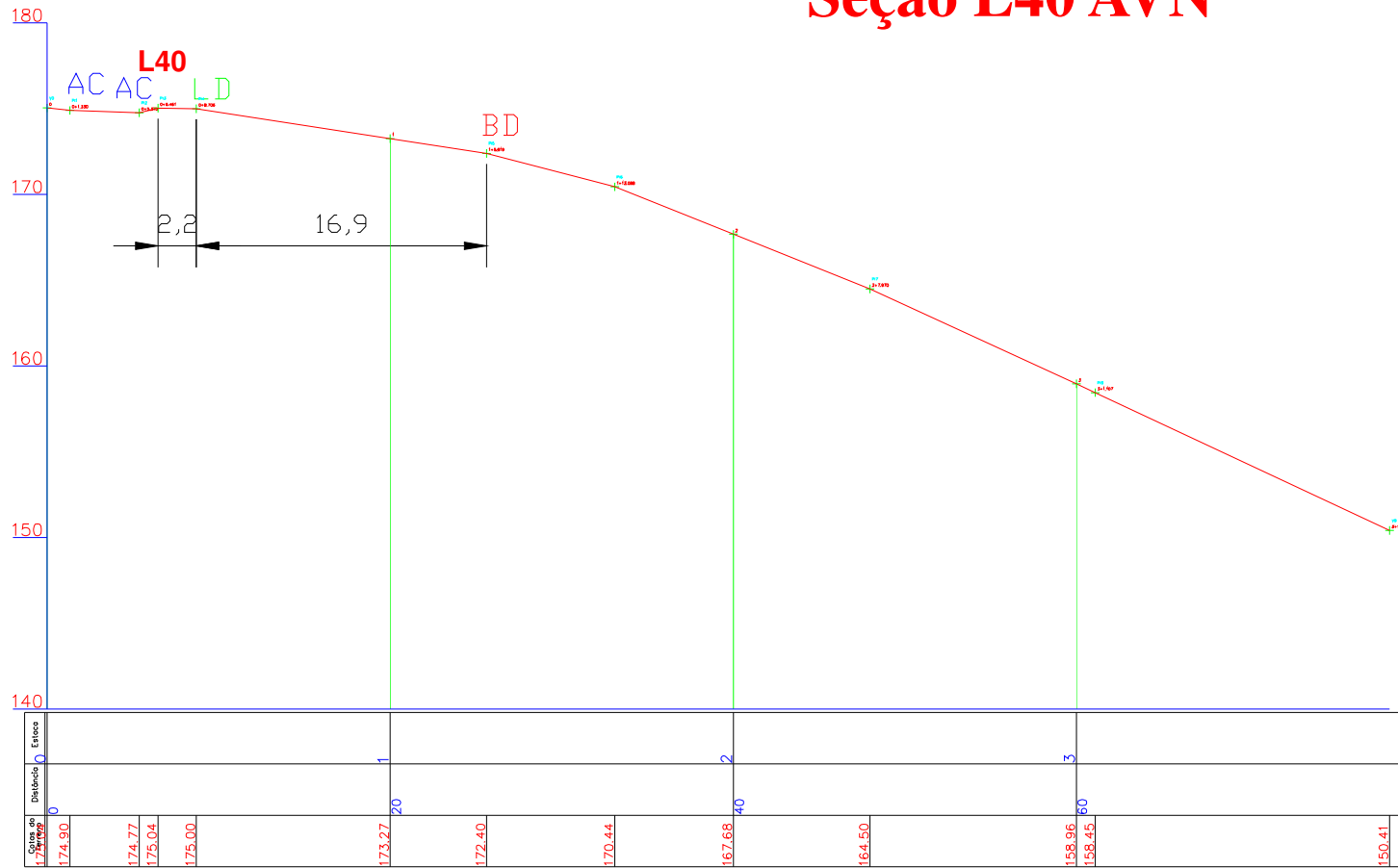

- AC - Acesso
- LD - Limite de Desmatamento
- BD - Borda
- AF - Afloramento
- BX - Bauxita ND - Nodular
- LT - Laterita

ESCALA 1:200 H 1:200 V



PERFIL LONGITUDINAL SEÇÕES DE BORDAS 2010

Seção L41 AVN

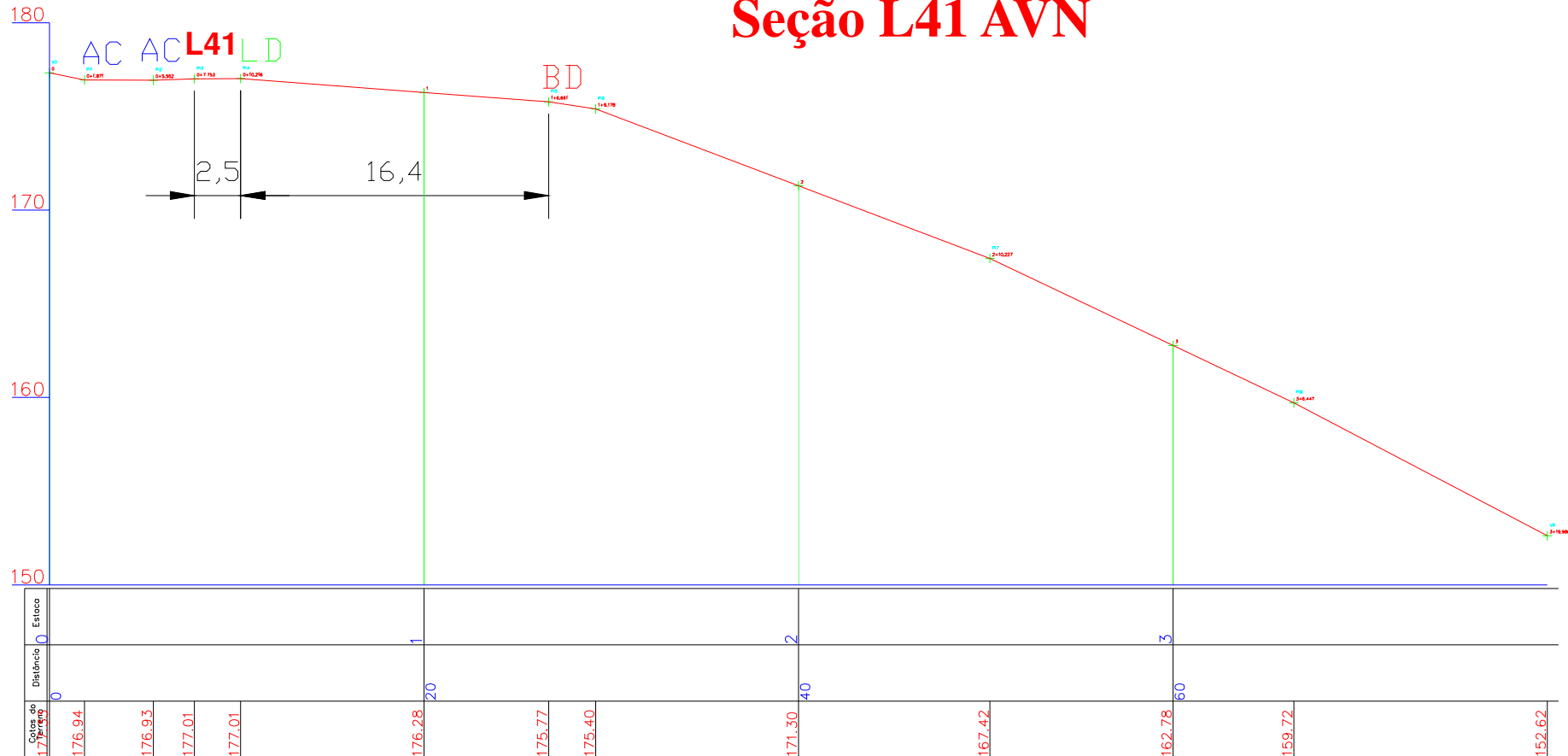

- AC - Acesso
- LD - Limite de Desmatamento
- BD - Borda
- AF - AFloramento
- BX - Bauxita ND - Nodular
- LT - Laterita

ESCALA 1:200 H 1:200 V

Seção L42 AVN

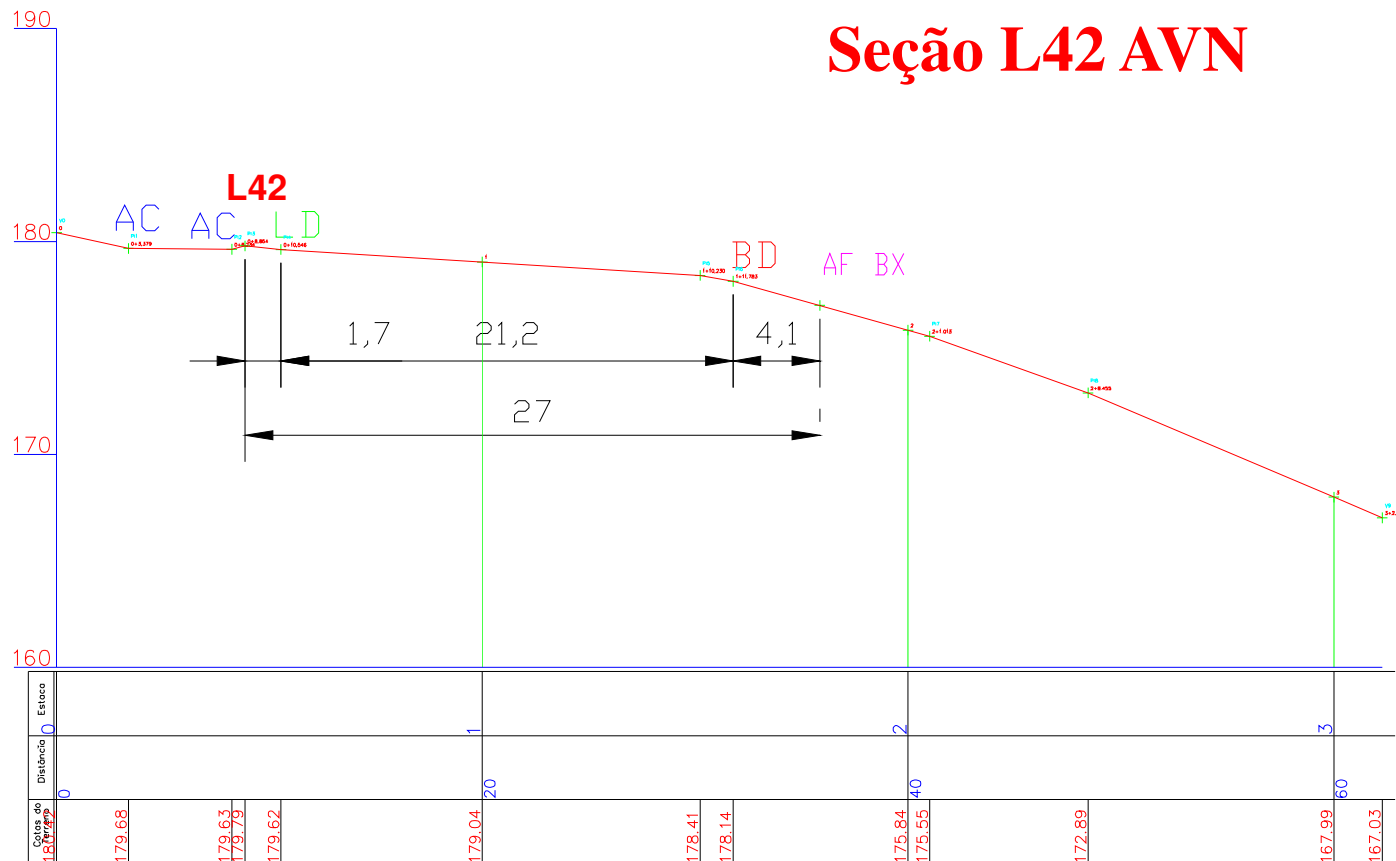

- AC - Acesso
- LD - Limite de Desmatamento
- BD - Borda
- AF - Afloramento
- BX - Bauxita ND - Nodular
- LT - Laterita

ESCALA 1:200 H 1:200 V

Seção L43 AVN

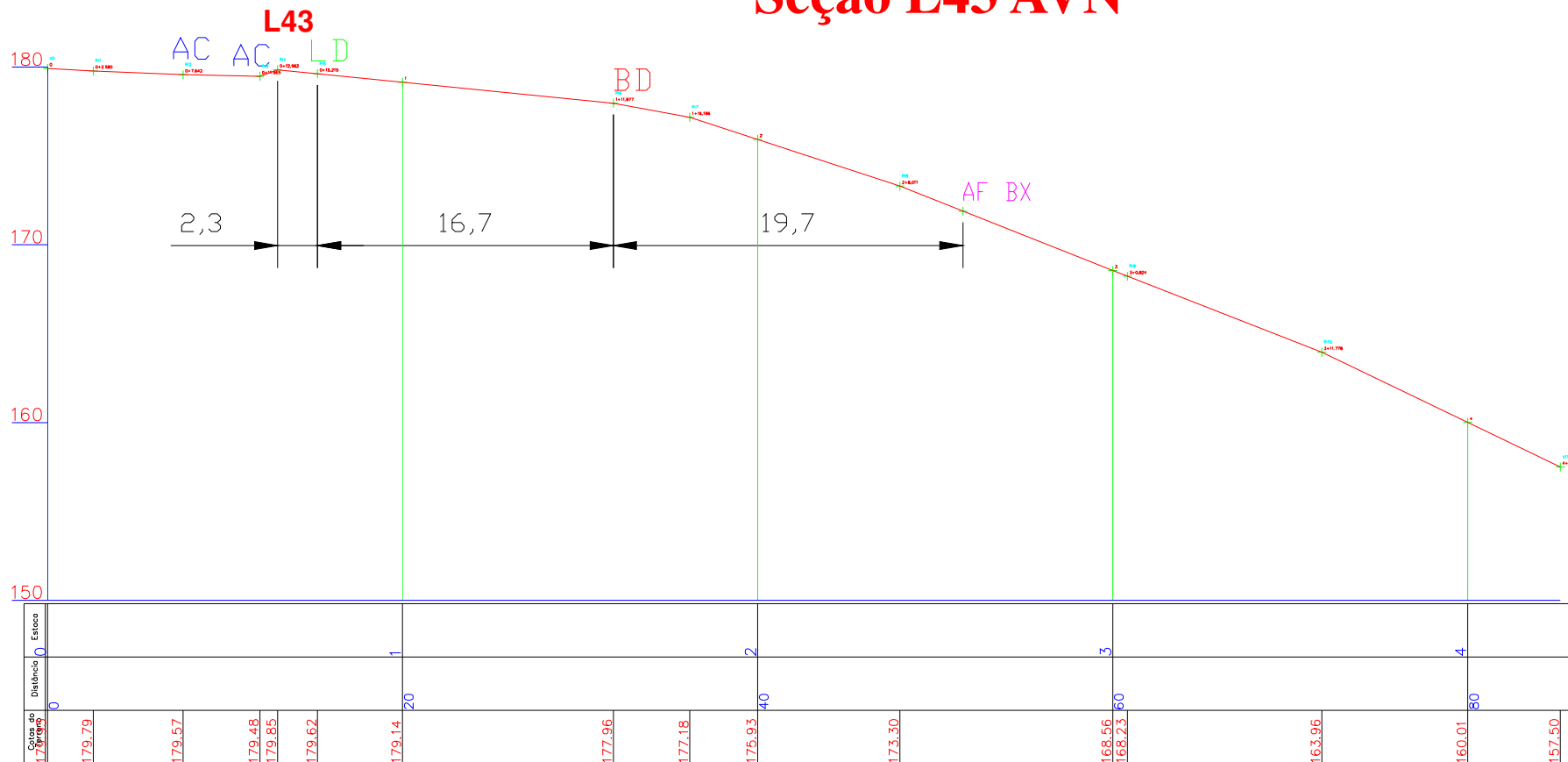

- AC - Acesso
- LD - Limite de Desmatamento
- BD - Borda
- AF - Afloramento
- BX - Bauxita
- ND - Nodular
- LT - Laterita

ESCALA 1:200 H 1:200 V

Seção L44 AVN

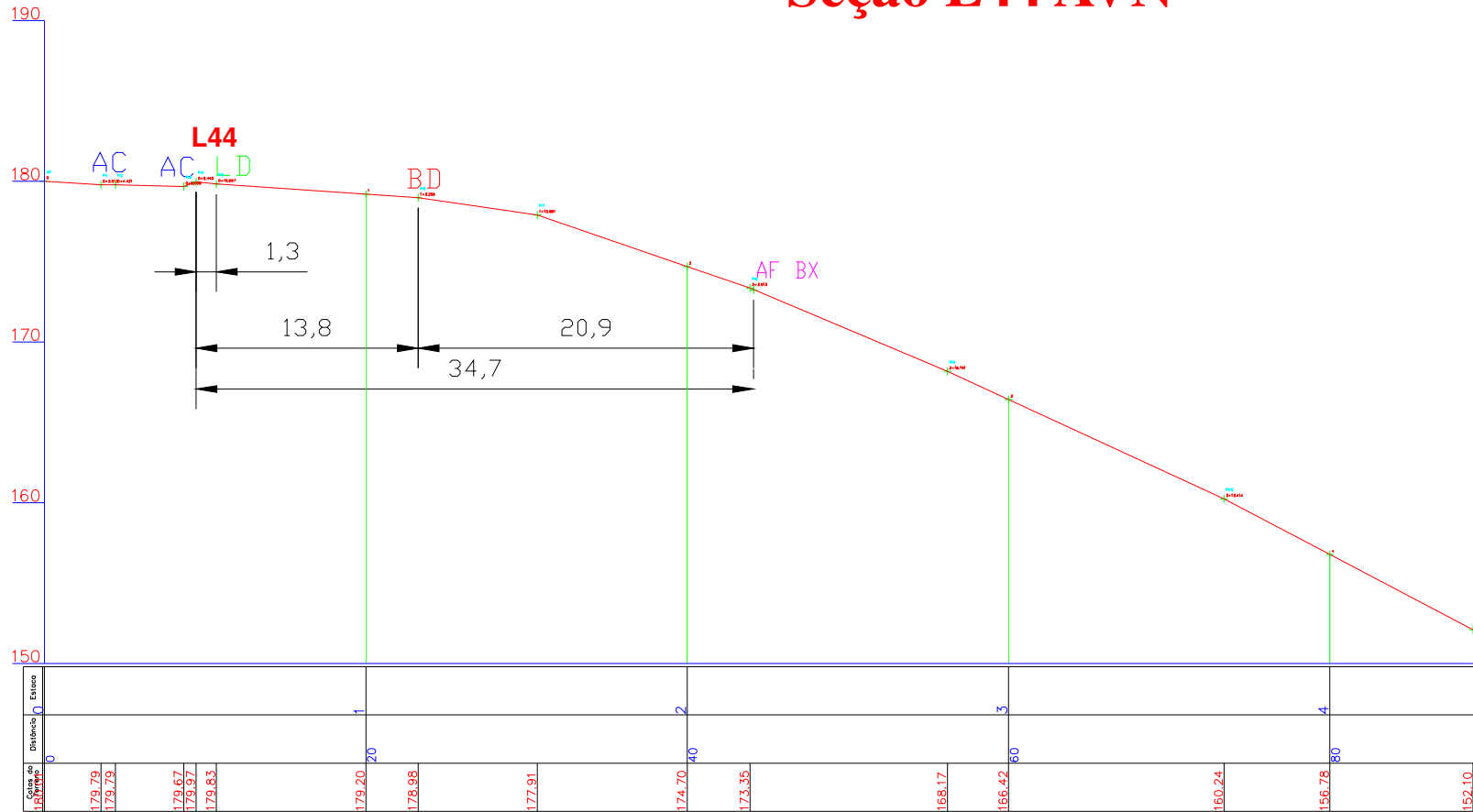

- AC - Acesso
- LD - Limite de Desmatamento
- BD - Borda
- AF - Afloramento
- BX - Bauxita ND - Nodular
- LT - Laterita

ESCALA 1:200 H 1:200 V



PERFIL LONGITUDINAL SEÇÕES DE BORDAS 2010

Seção L45 AVN



- AC - Acesso
- LD - Limite de Desmatamento
- BD - Borda
- AF - Afloramento
- BX - Bauxita ND - Nodular
- LT - Laterita

ESCALA 1:200 H 1:200 V

Seção L46 AVN

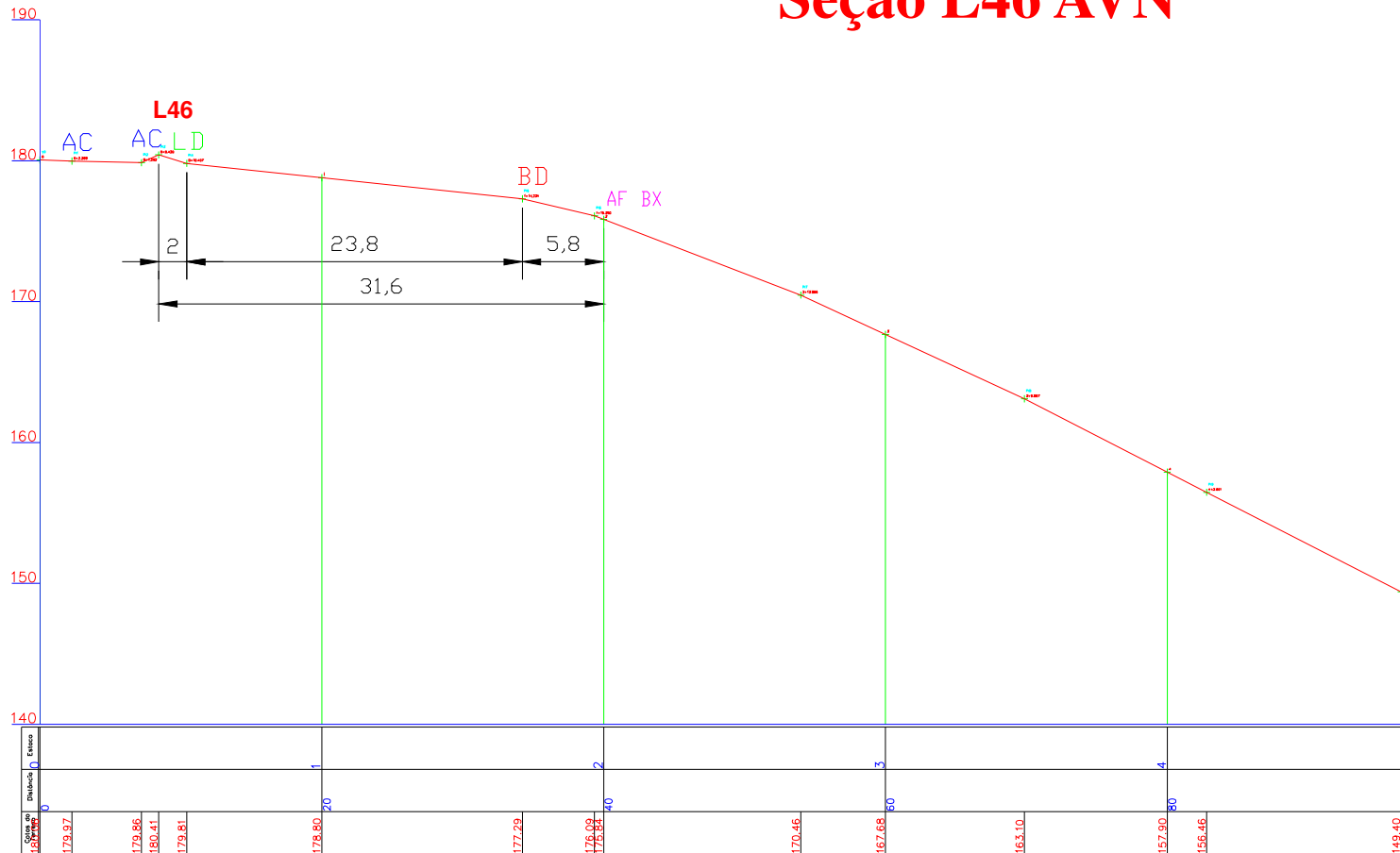

AC - Acesso
 LD - Limite de Desmatamento
 BD - Borda
 AF - Afloramento
 BX - Bauxita ND - Nodular
 LT - Laterita

ESCALA 1:200 H 1:200 V



PERFIL LONGITUDINAL SEÇÕES DE BORDAS 2010

Seção L47 AVN

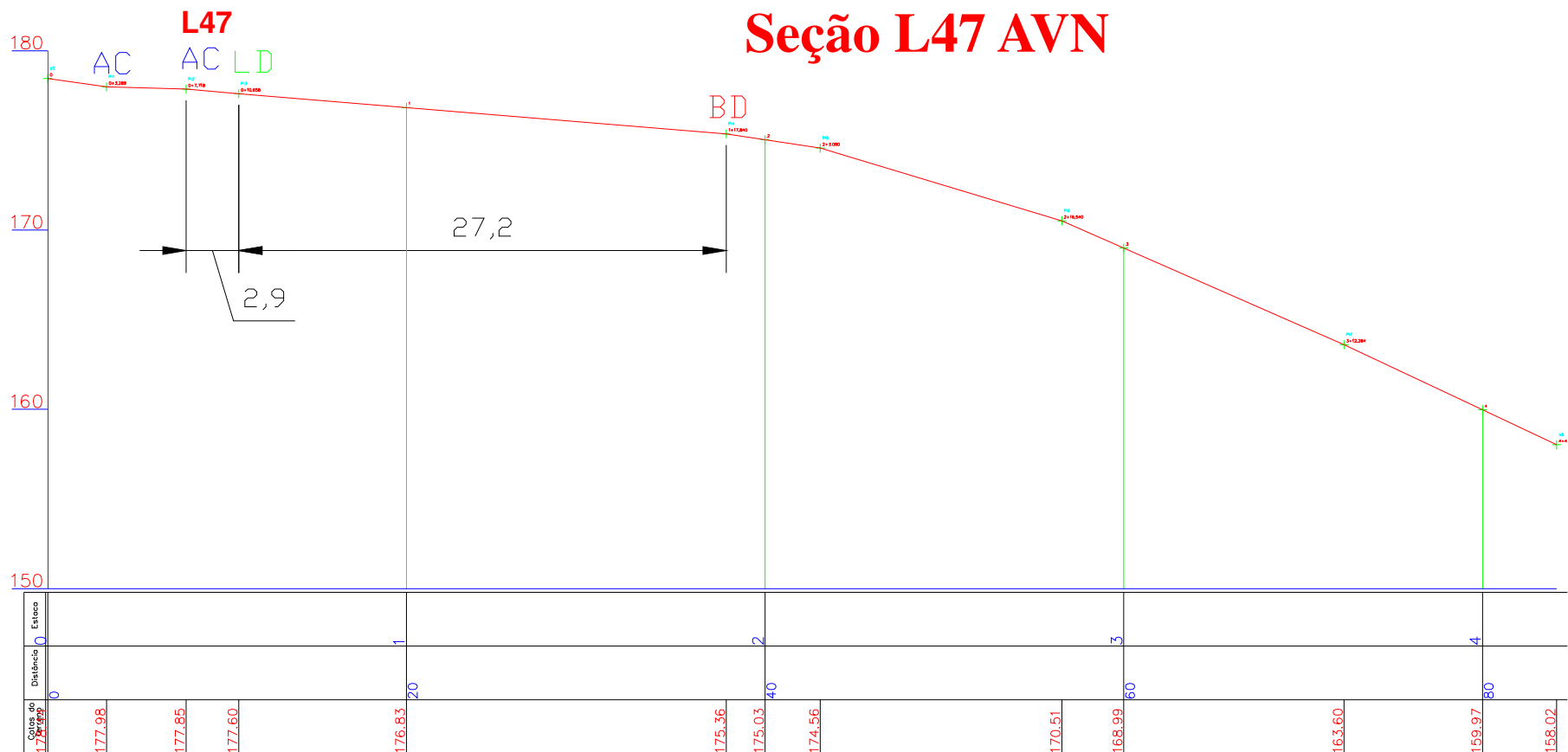

AC - Acesso
LD - Limite de Desmatamento
BD - Borda
AF - Afloramento
BX - Bauxita ND - Nodular
LT - Laterita

ESCALA 1:200 H 1:200 V

Seção L48 AVN

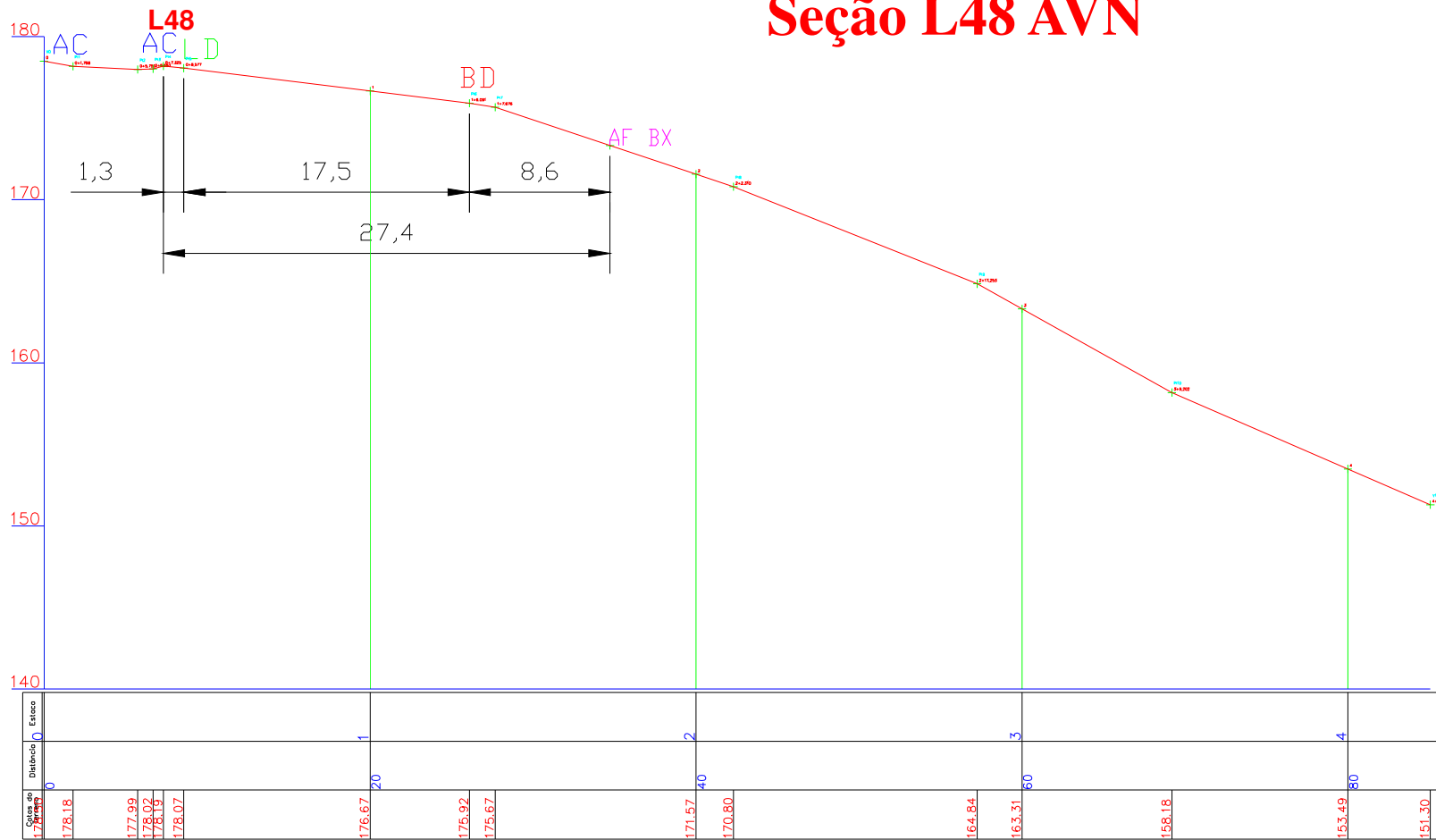

AC - Acesso
 LD - Limite de Desmatamento
 BD - Borda
 AF - Afloramento
 BX - Bauxita ND - Nodular
 LT - Laterita

ESCALA 1:200 H 1:200 V

Seção L49 AVN

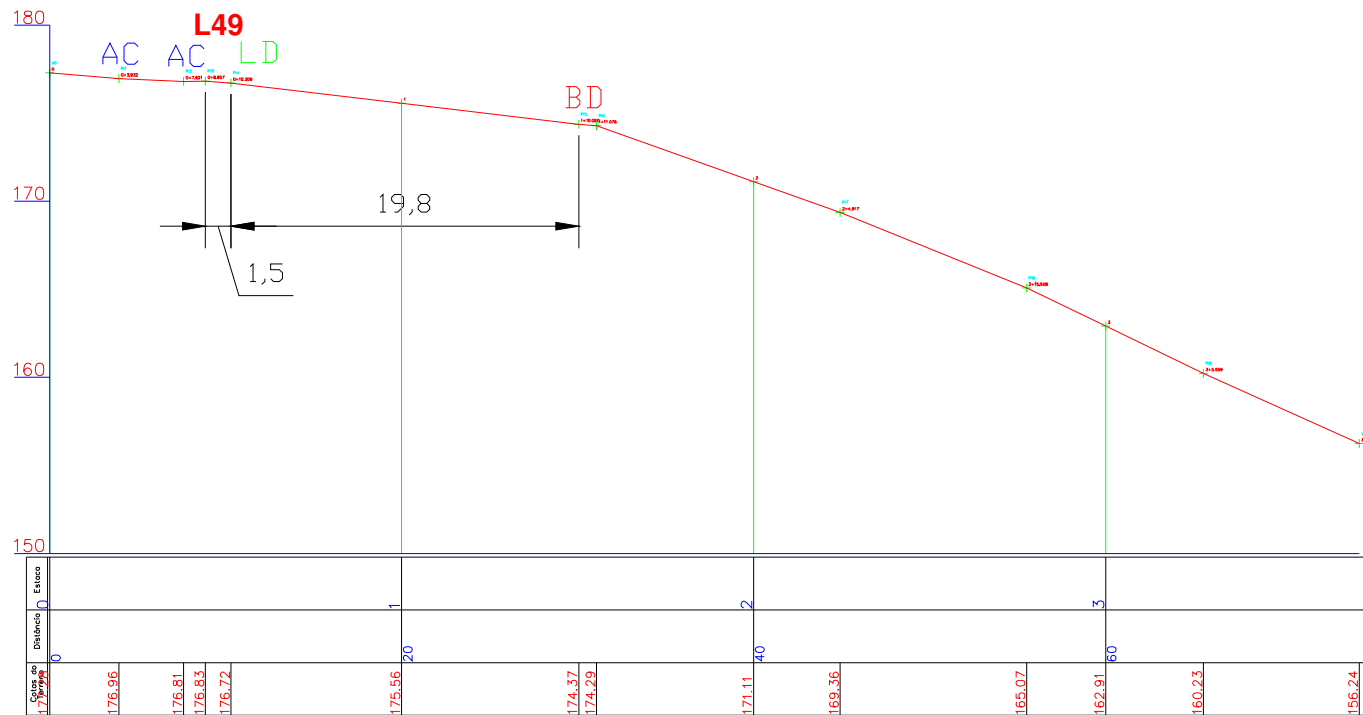

AC - Acesso
 LD - Limite de Desmatamento
 BD - Borda
 AF - Afloramento
 BX - Bauxita ND - Nodular
 LT - Laterita

ESCALA 1:200 H 1:200 V



PERFIL LONGITUDINAL SEÇÕES DE BORDAS 2010

Seção L50 AVN

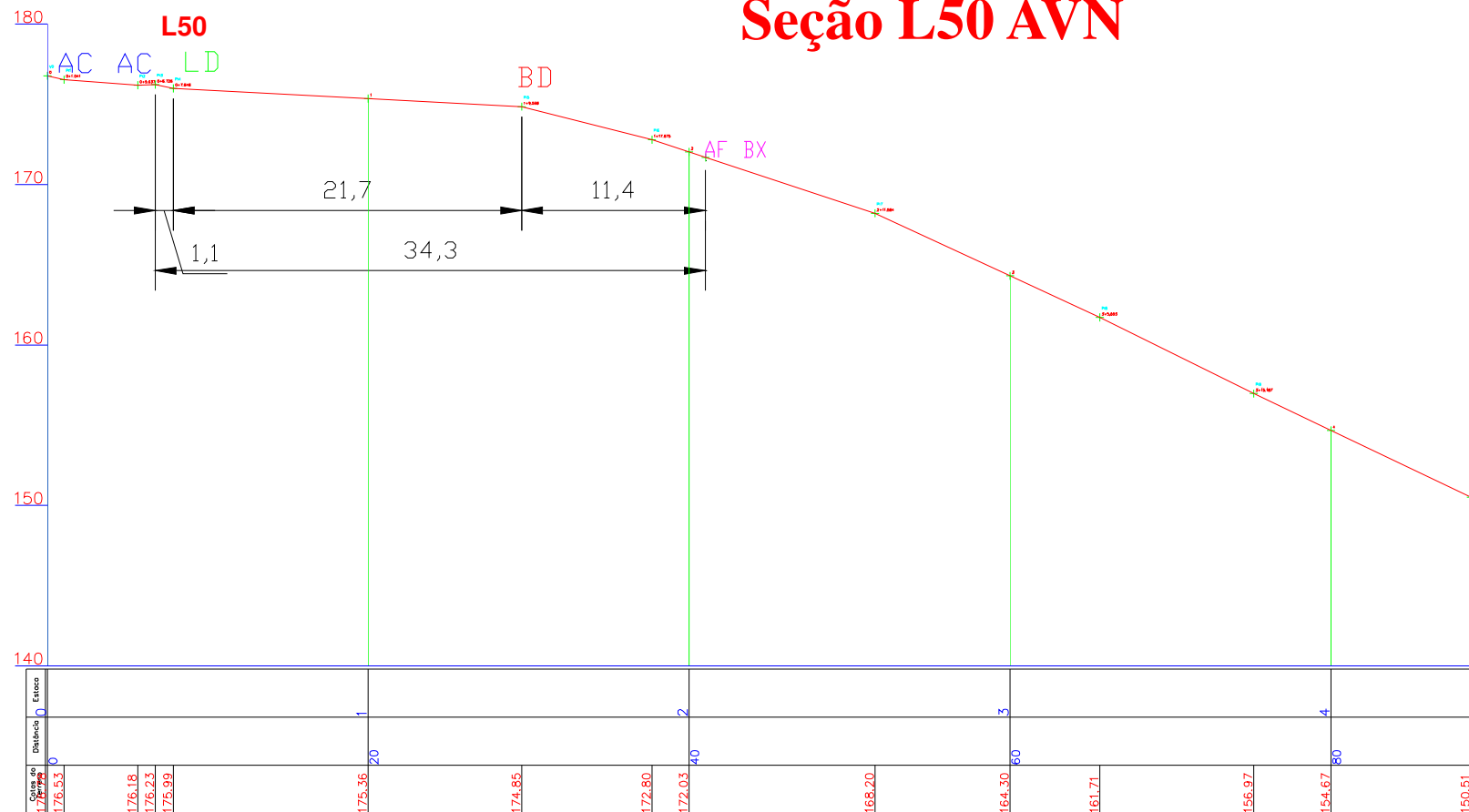

AC - Acesso
LD - Limite de Desmatamento
BD - Borda
AF - Afloramento
BX - Bauxita ND - Nodular
LT - Laterita

ESCALA 1:200 H 1:200 V



PERFIL LONGITUDINAL SEÇÕES DE BORDAS 2010

Seção L51 AVN

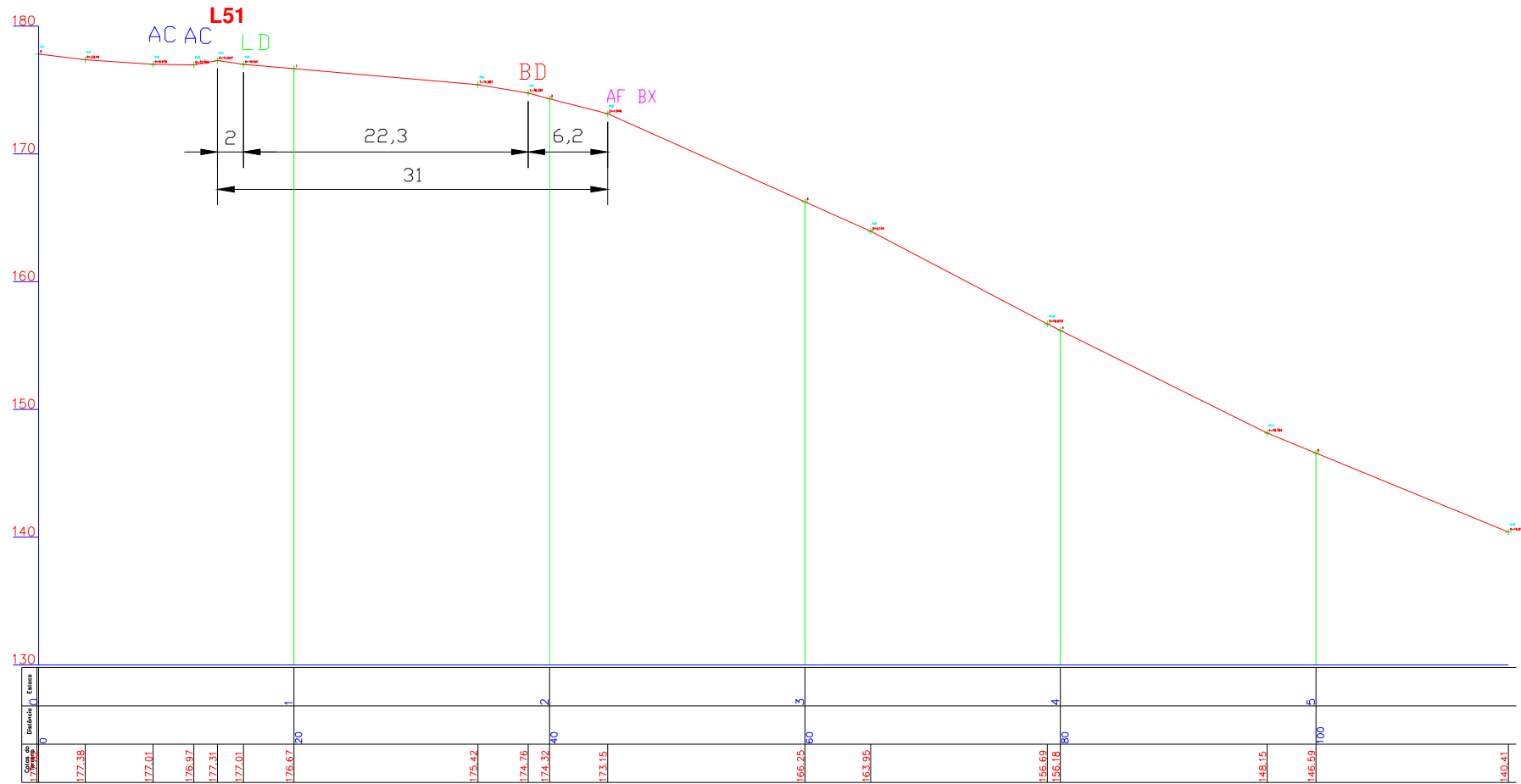

AC - Acesso
LD - Limite de Desmatamento
BD - Borda
AF - Afloramento
BX - Bauxita ND - Nodular
LT - Laterita

ESCALA 1:200 H 1:200 V

Seção L52 AVN

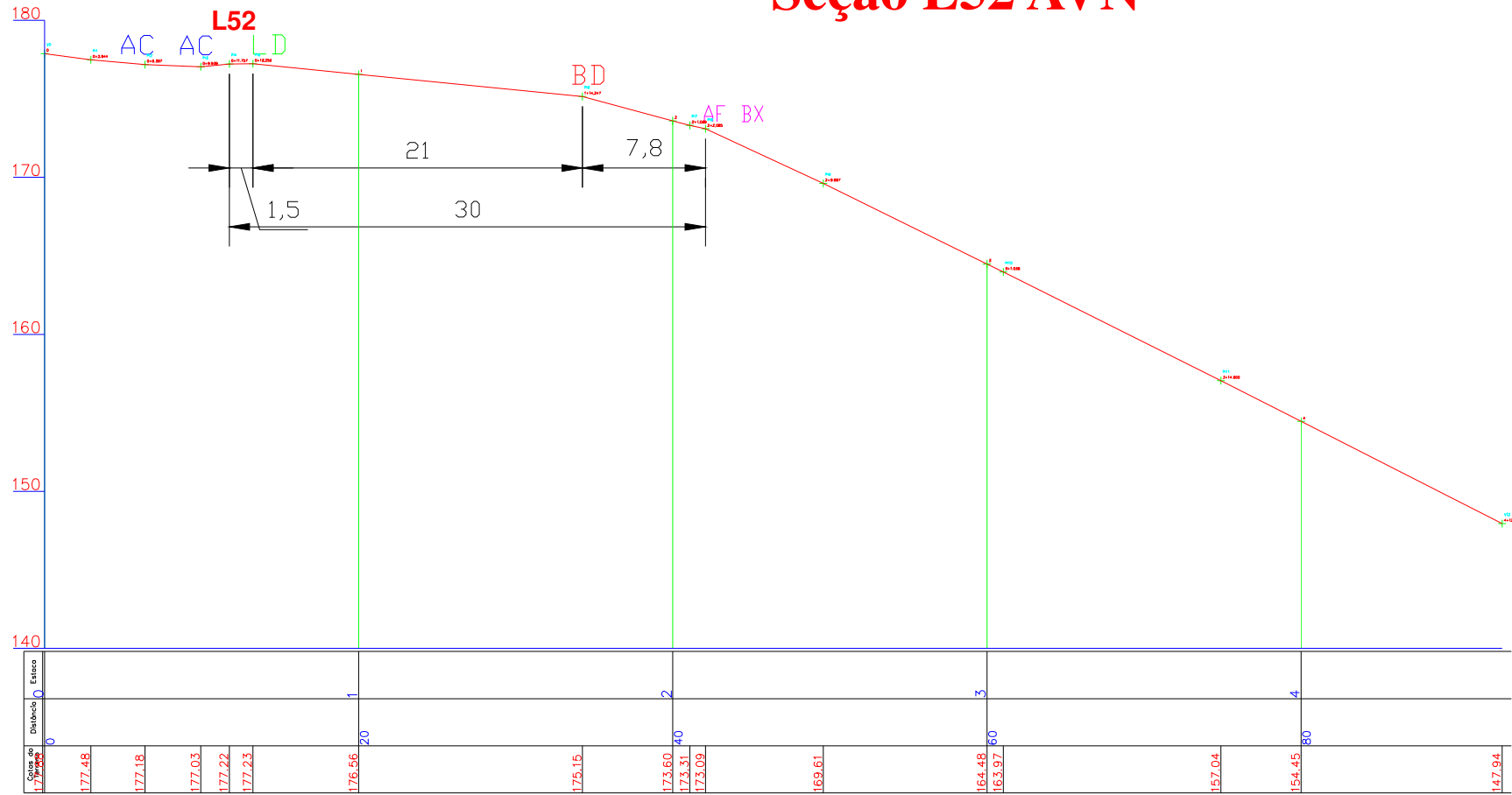

- AC - Acesso
- LD - Limite de Desmatamento
- BD - Borda
- AF - Afloramento
- BX - Bauxita ND - Nodular
- LT - Laterita

ESCALA 1:200 H 1:200 V

Seção L53 AVN

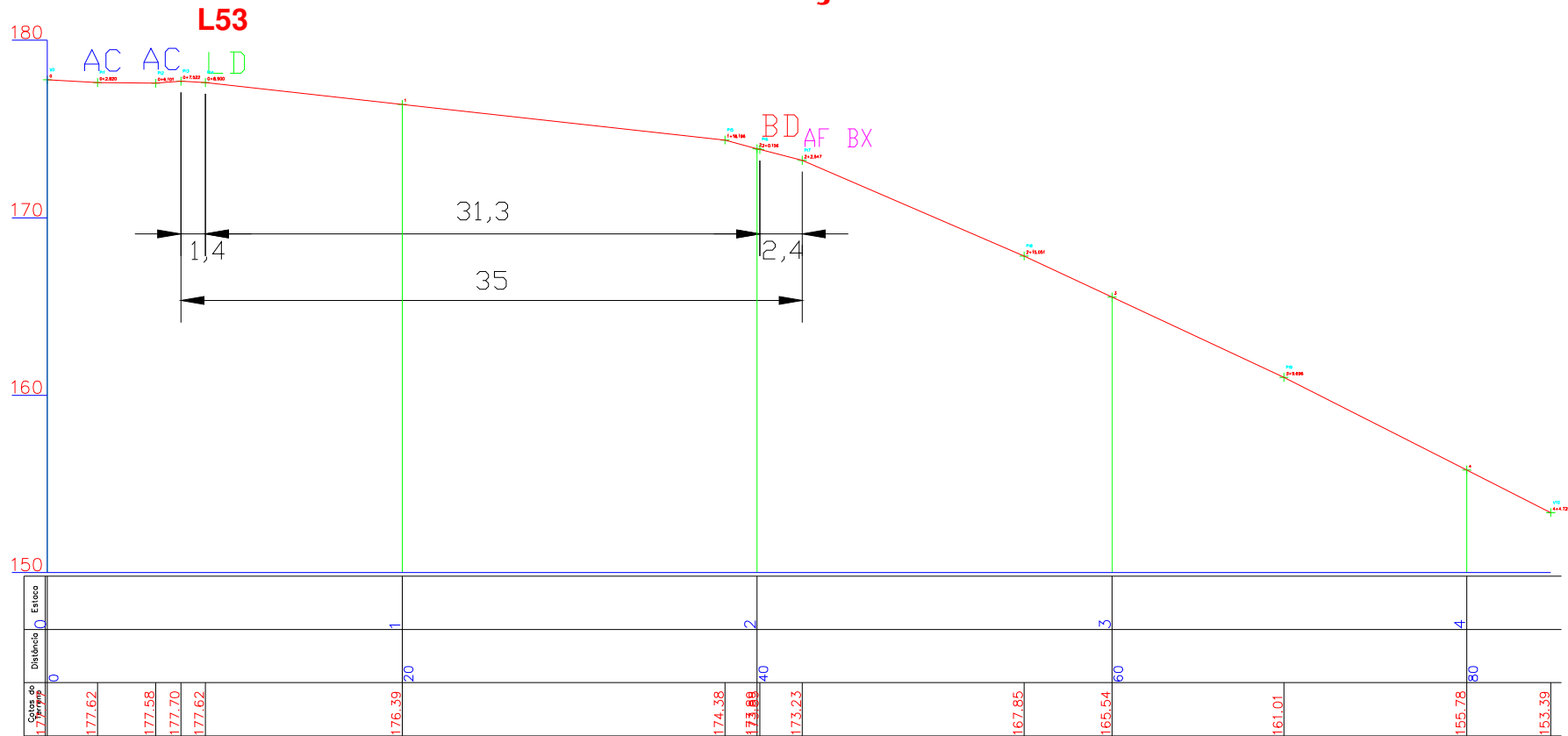

- AC - Acesso
- LD - Limite de Desmatamento
- BD - Borda
- AF - Afloramento
- BX - Bauxita ND - Nodular
- LT - Laterita

ESCALA 1:200 H 1:200 V

Seção L54 AVN

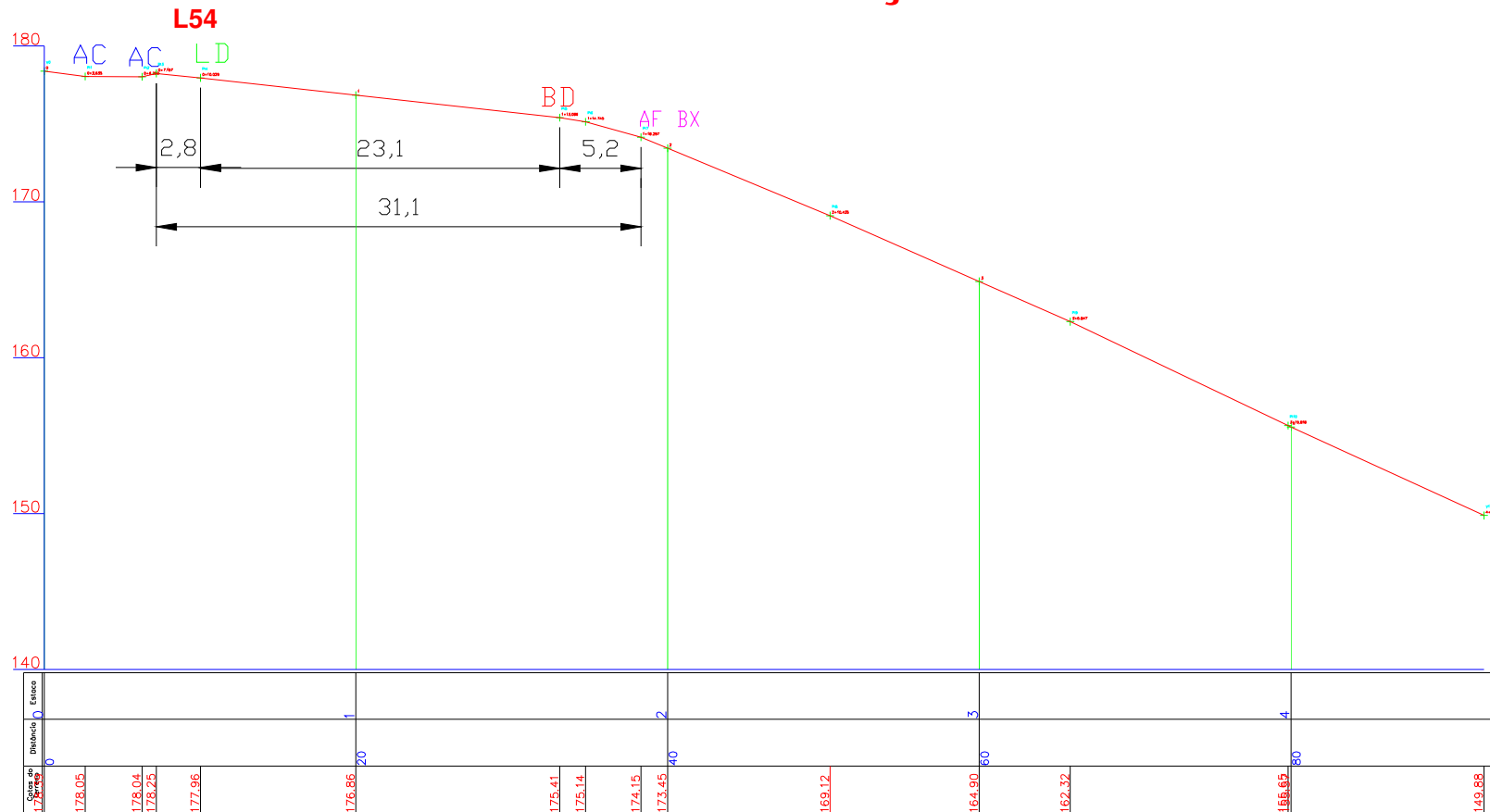

- AC - Acesso
- LD - Limite de Desmatamento
- BD - Borda
- AF - Afloramento
- BX - Bauxita ND - Nodular
- LT - Laterita

ESCALA 1:200 H 1:200 V



PERFIL LONGITUDINAL SEÇÕES DE BORDAS 2010

Seção L55 AVN

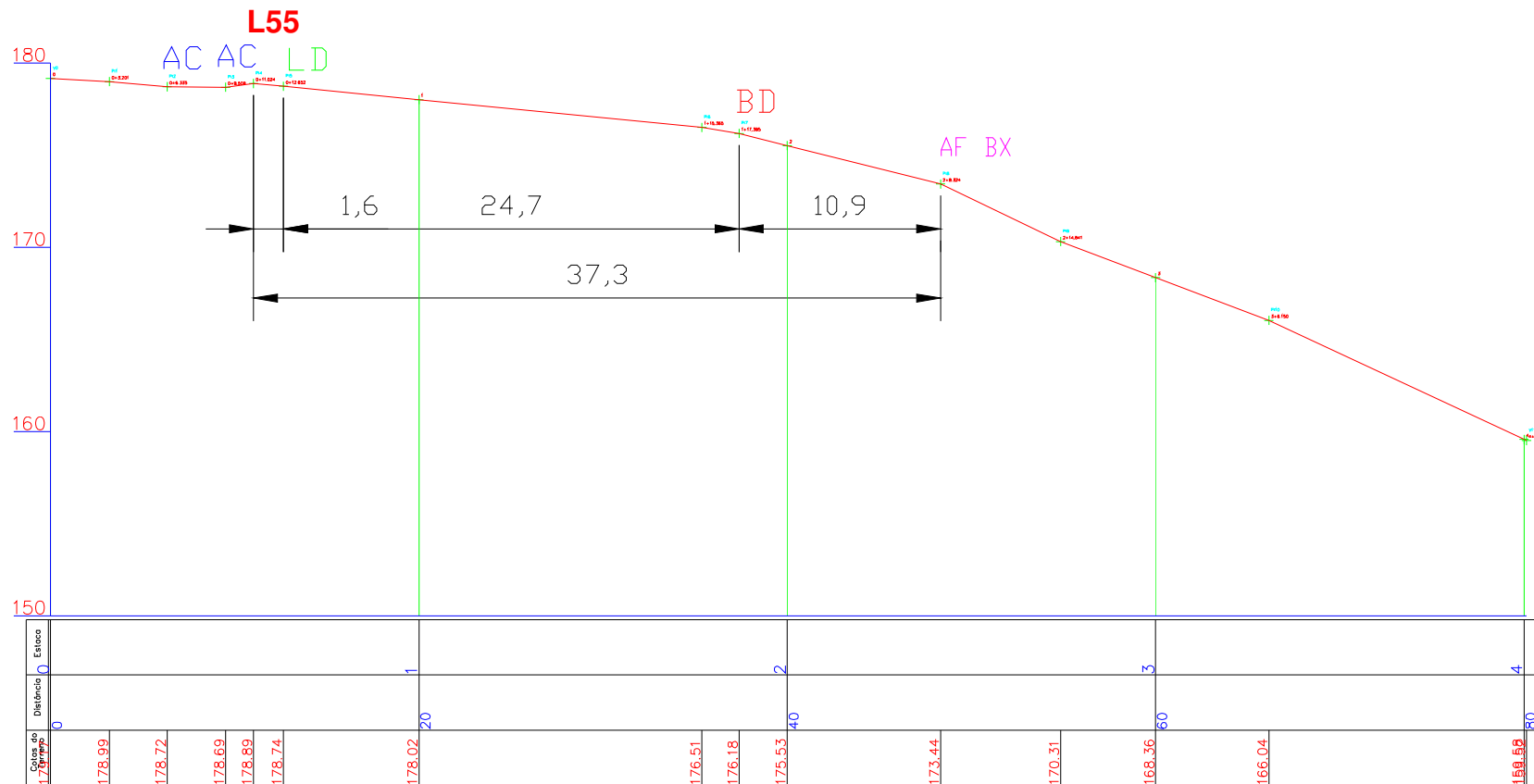

- AC - Acesso
- LD - Limite de Desmatamento
- BD - Borda
- AF - Afloramento
- BX - Bauxita ND - Nodular
- LT - Laterita

ESCALA 1:200 H 1:200 V

Seção L56 AVN

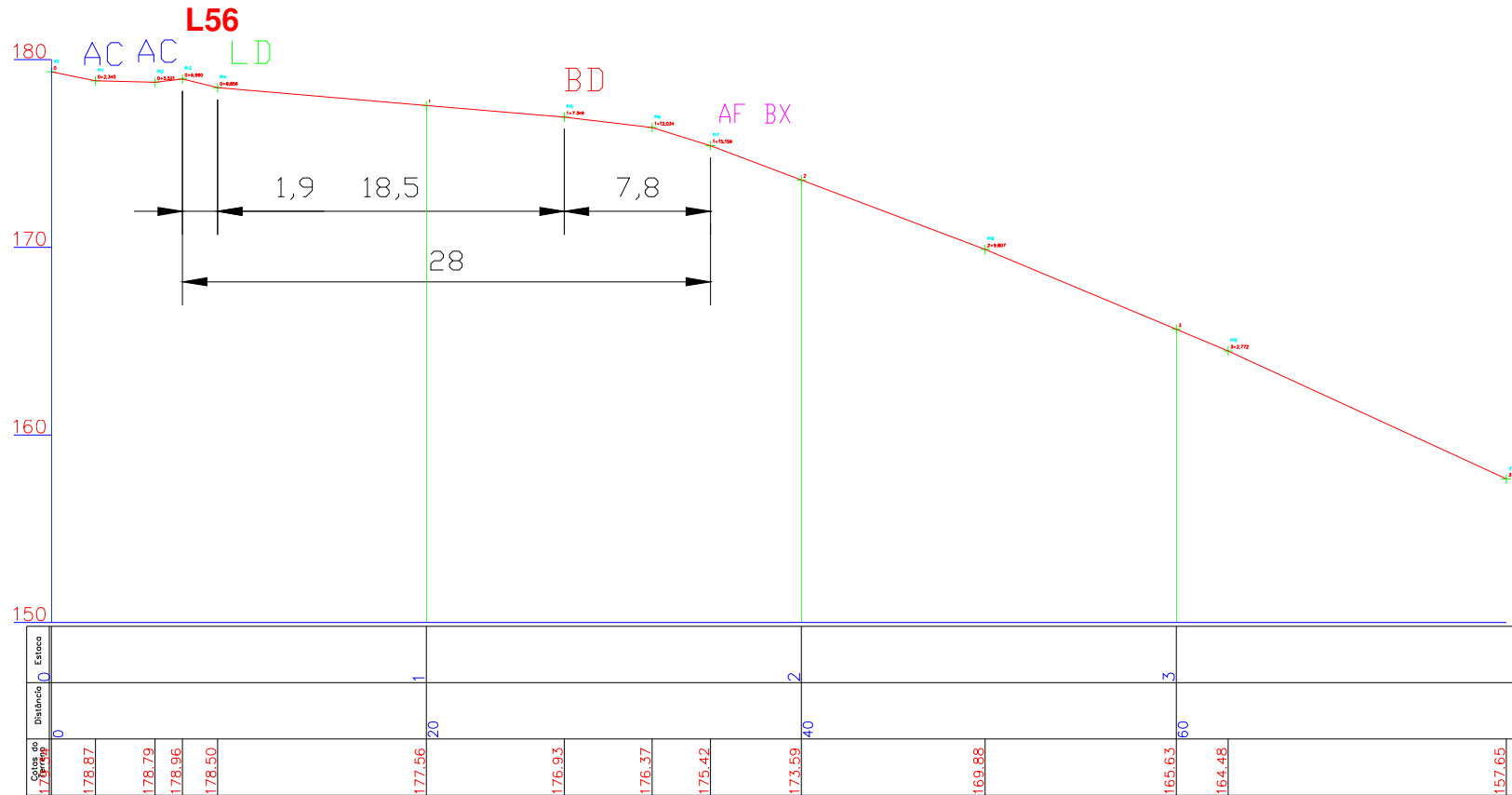

- AC - Acesso
- LD - Limite de Desmatamento
- BD - Borda
- AF - Afloramento
- BX - Bauxita ND - Nodular
- LT - Laterita

ESCALA 1:200 H 1:200 V

Seção L57 AVN

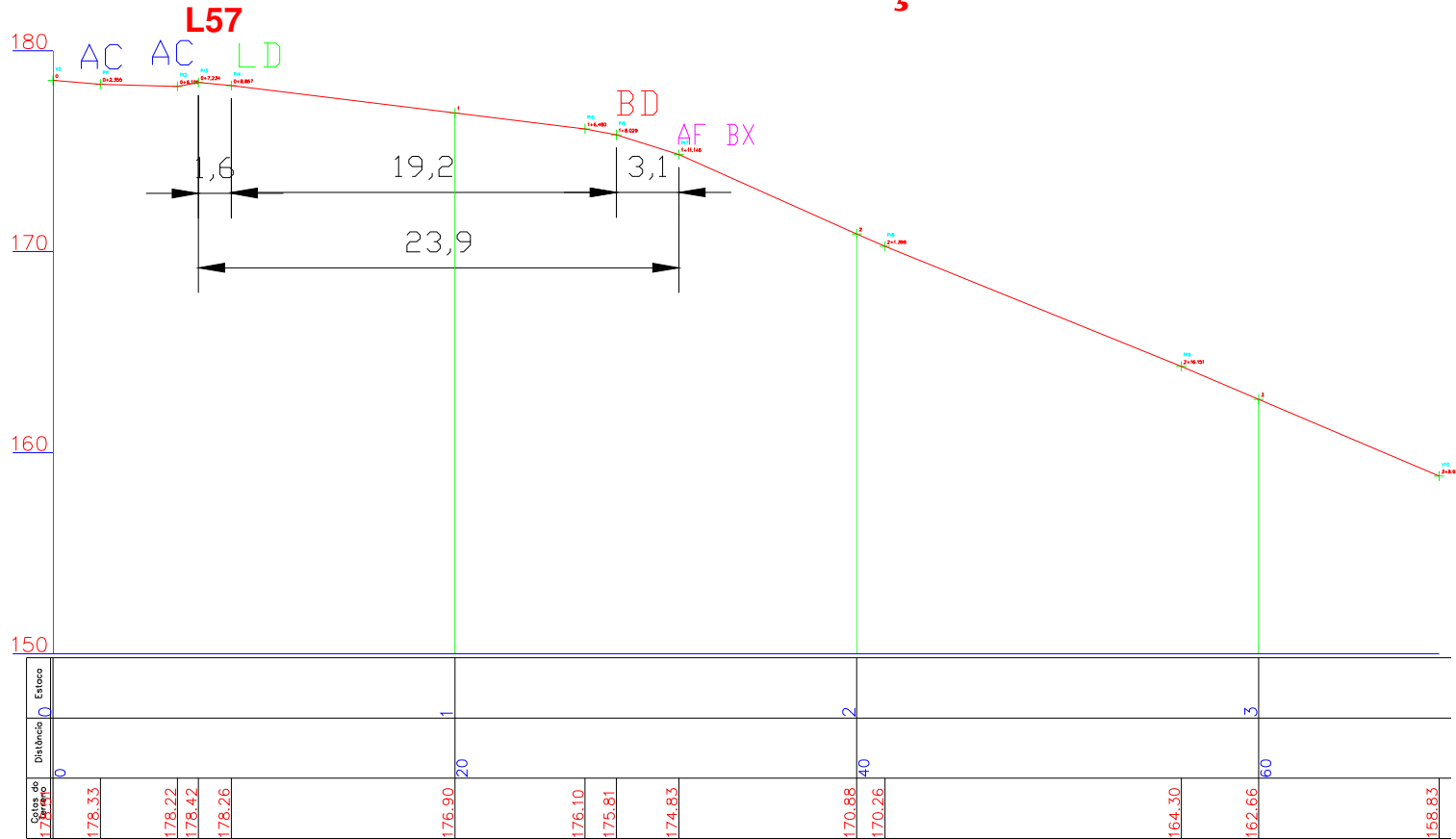

AC - Acesso
 LD - Limite de Desmatamento
 BD - Borda
 AF - Afloramento
 BX - Bauxita ND - Nodular
 LT - Laterita

ESCALA 1:200 H 1:200 V

Seção L58 AVN

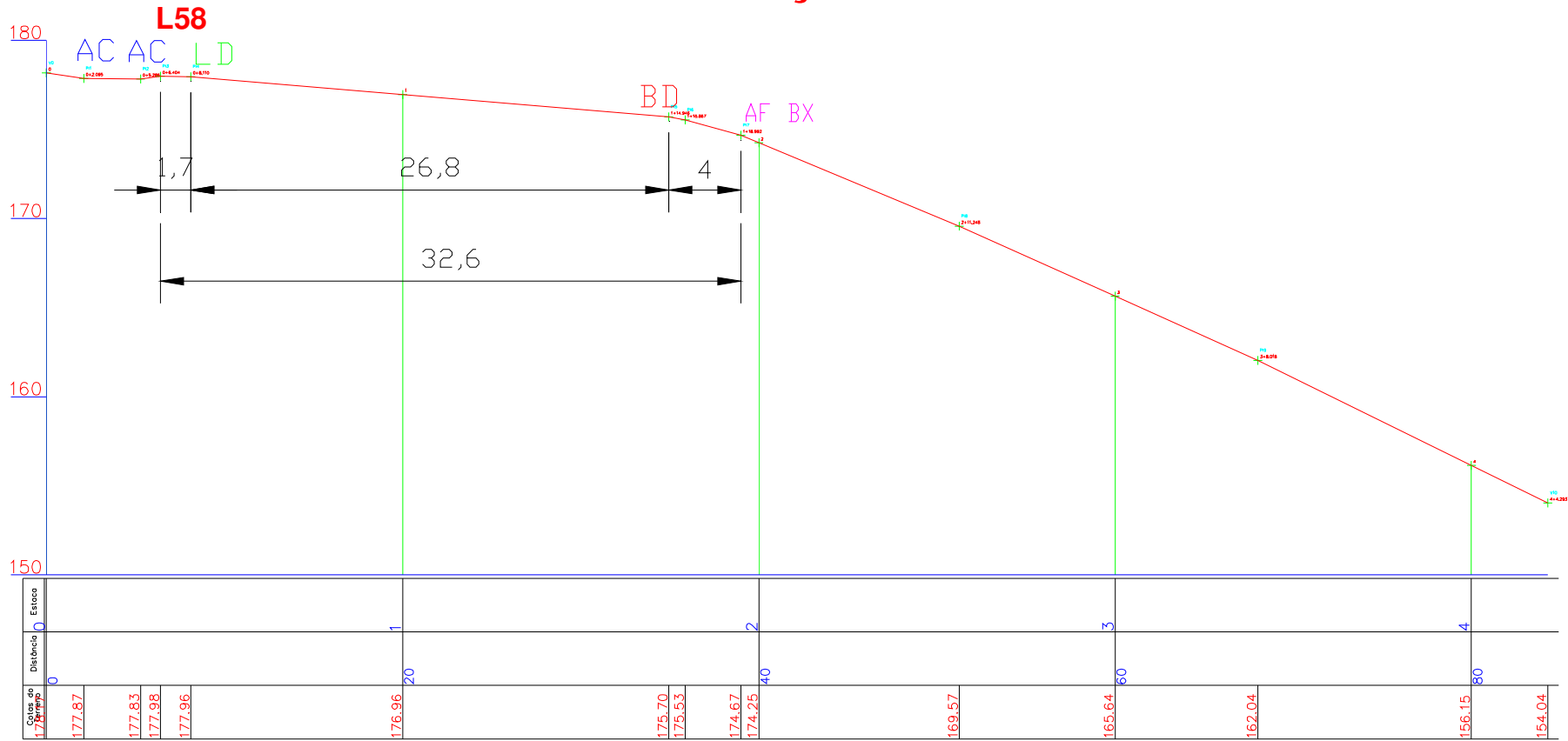

- AC - Acesso
- LD - Limite de Desmatamento
- BD - Borda
- AF - Afloramento
- BX - Bauxita ND - Nodular
- LT - Laterita

ESCALA 1:200 H 1:200 V



PERFIL LONGITUDINAL SEÇÕES DE BORDAS 2010

Seção L59 AVN

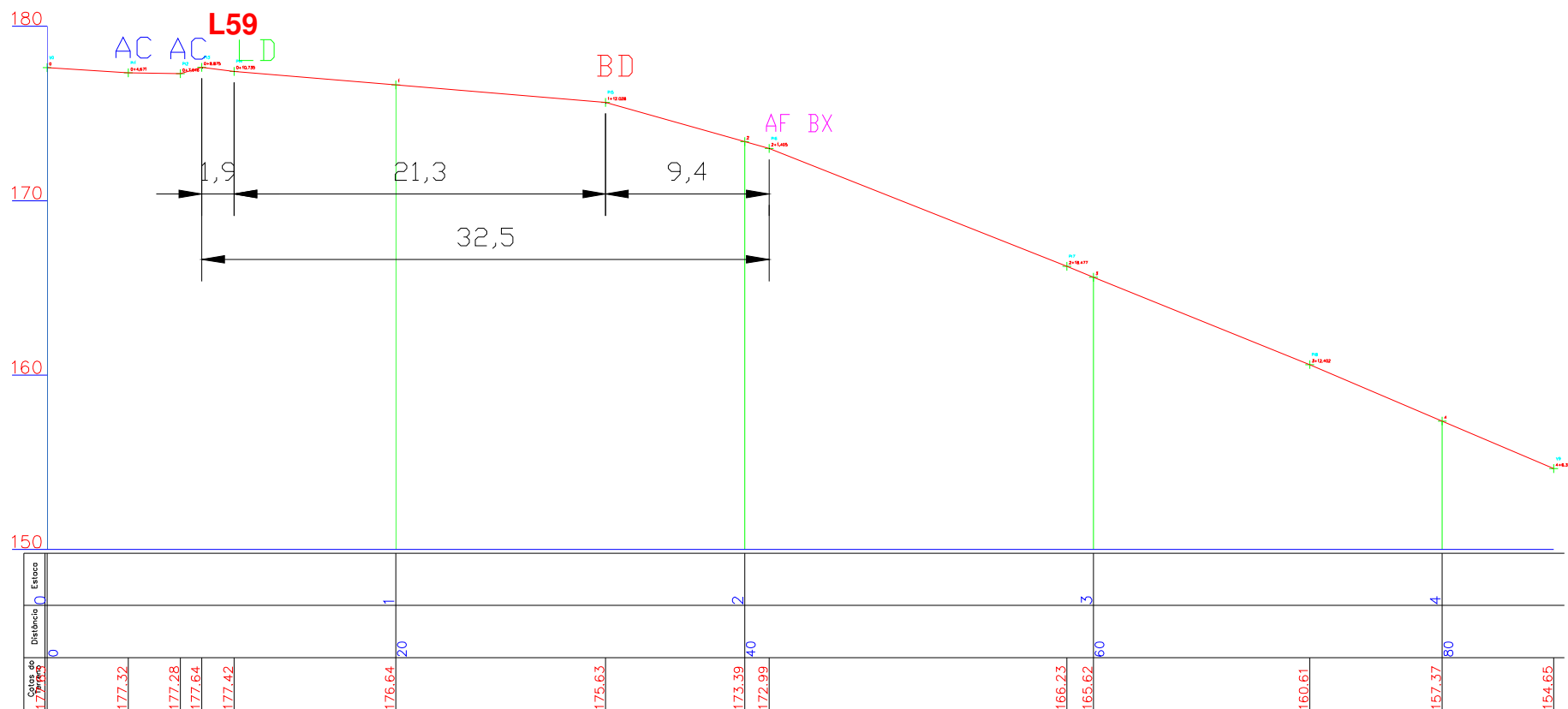

- AC - Acesso
- LD - Limite de Desmatamento
- BD - Borda
- AF - Afloramento
- BX - Bauxita ND - Nodular
- LT - Laterita

ESCALA 1:200 H 1:200 V

Seção L60 AVN

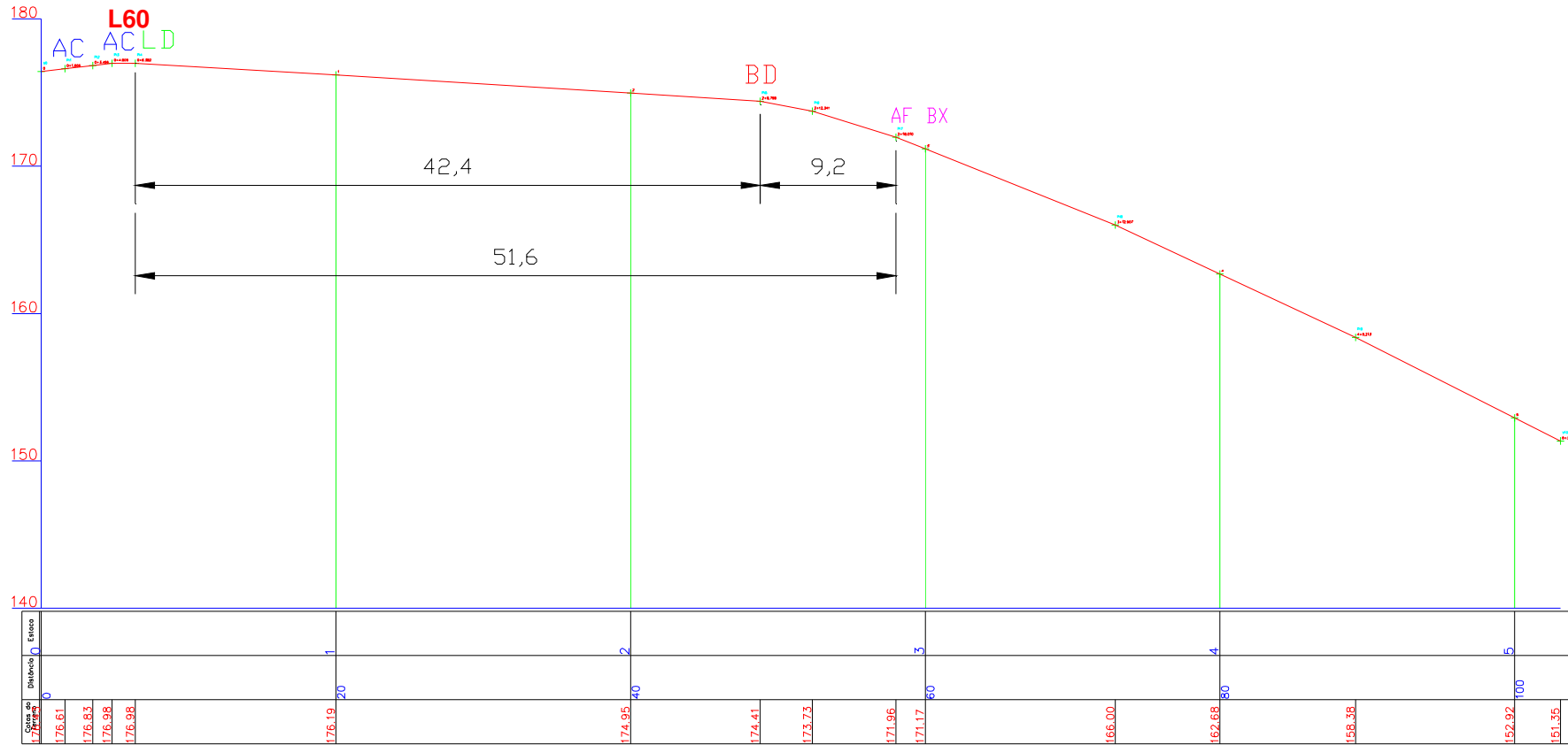

- AC - Acesso
- LD - Limite de Desmatamento
- BD - Borda
- AF - Afloramento
- BX - Bauxita ND - Nodular
- LT - Laterita

ESCALA 1:200 H 1:200 V



PERFIL LONGITUDINAL SEÇÕES DE BORDAS 2010

Seção L61 AVN

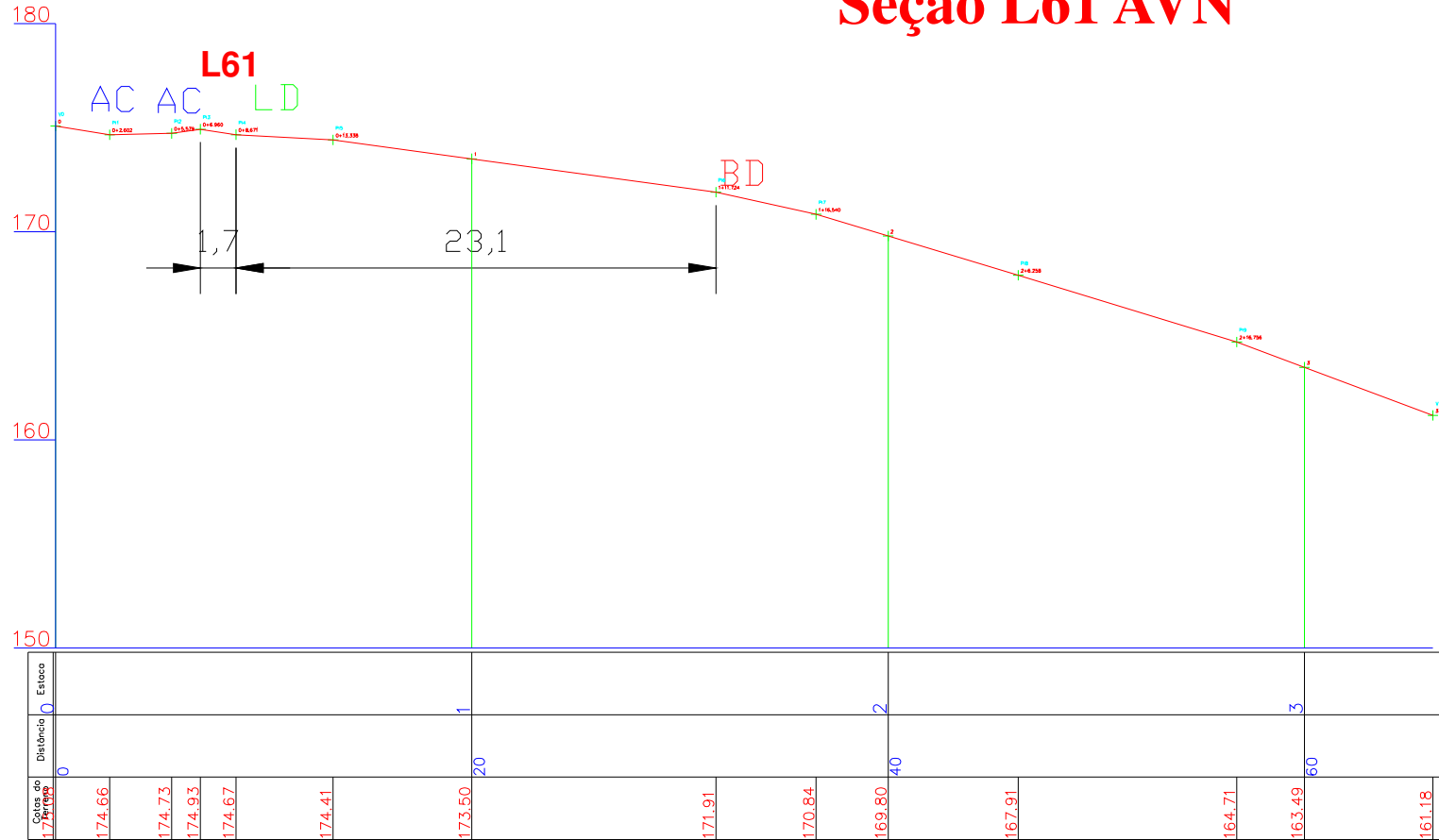

AC - Acesso
LD - Limite de Desmatamento
BD - Borda
AF - Afloramento
BX - Bauxita ND - Nodular
LT - Laterita

ESCALA 1:200 H 1:200 V

Seção L62 AVN

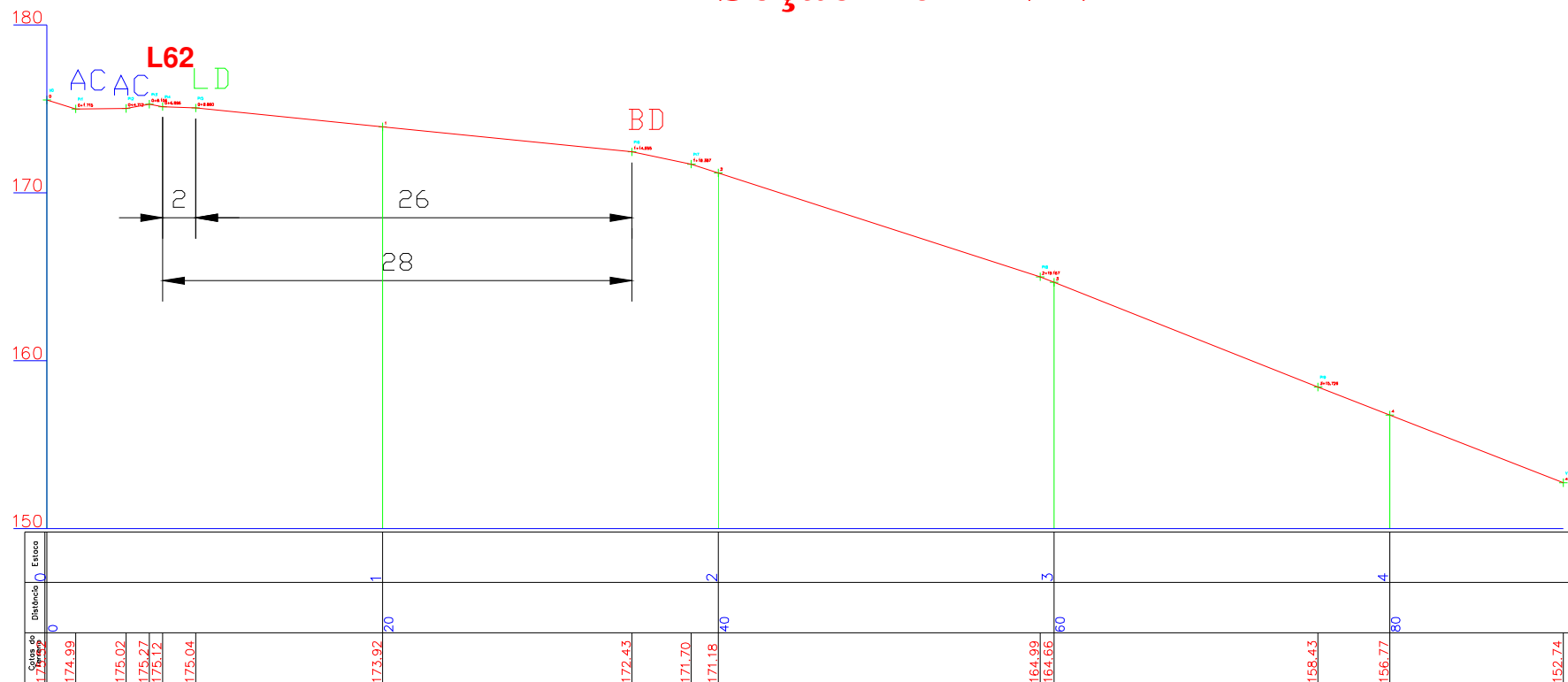

- AC - Acesso
- LD - Limite de Desmatamento
- BD - Borda
- AF - Afloramento
- BX - Bauxita ND - Nodular
- LT - Laterita

ESCALA 1:200 H 1:200 V

Seção 43 AVN

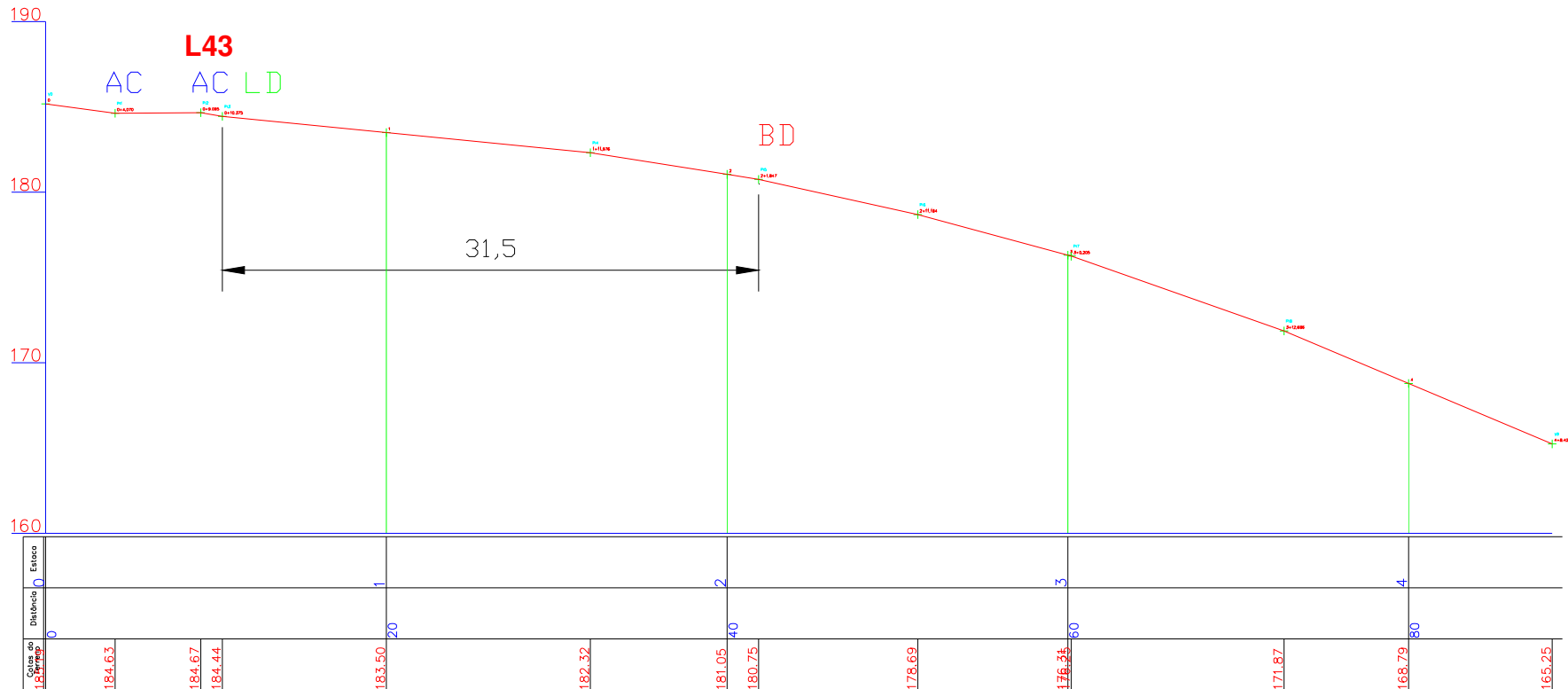

AC - Acesso
 SD - Simite de Desmatamento
 BD - Borda
 AF - AFSoramento
 BX - Bauxita ND - NoduSar
 ST - Saterita

ESCASA 1:200 H 1:200 V



PERFIL LONGITUDINAL SEÇÕES DE BORDAS 2010

Seção 44 AVN

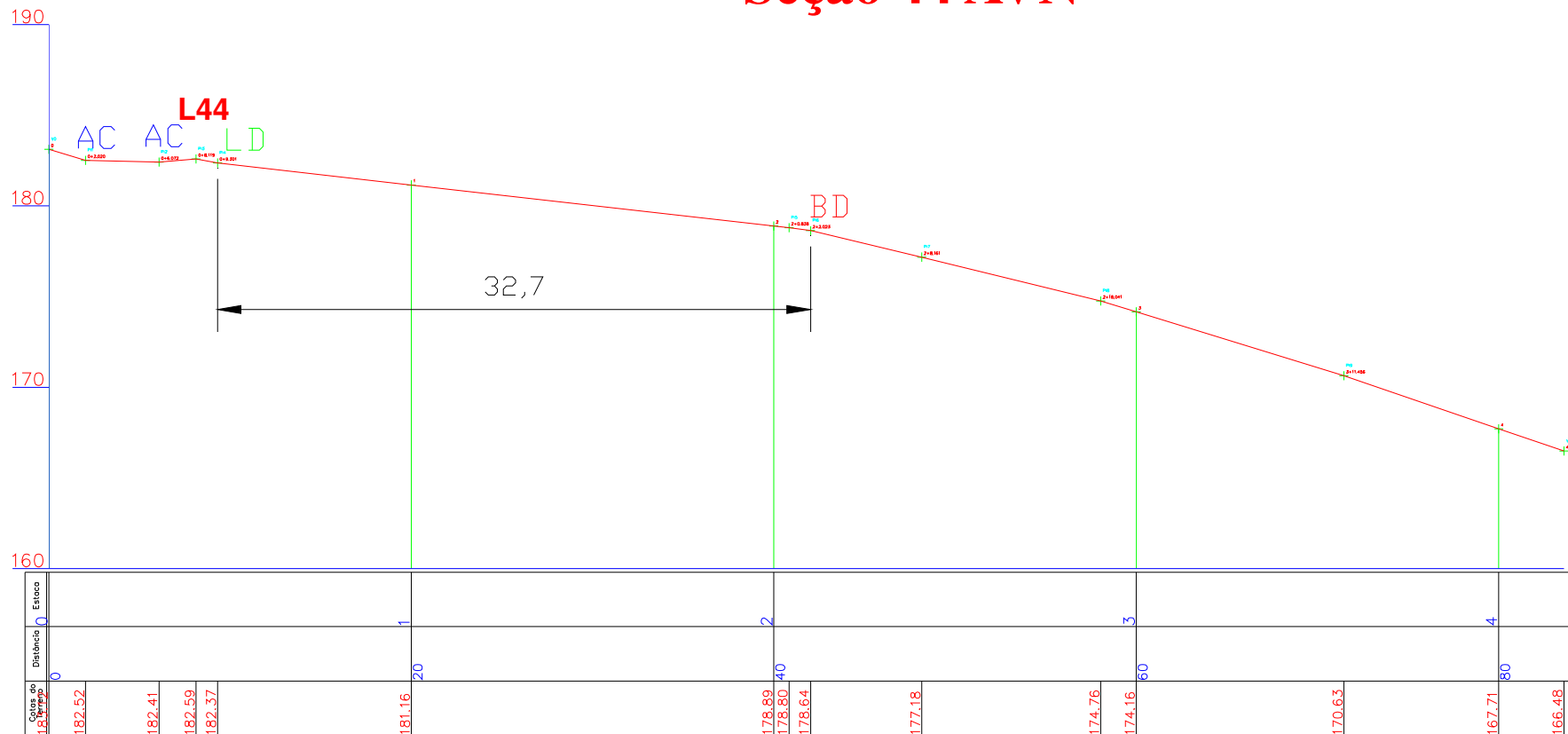

- AC - Acesso
- SD - Simite de Desmatamento
- BD - Borda
- AF - AFSoramento
- BX - Bauxita ND - NoduSar
- ST - Saterita

ESCASA 1:200 H 1:200 V

Seção 45 AVN

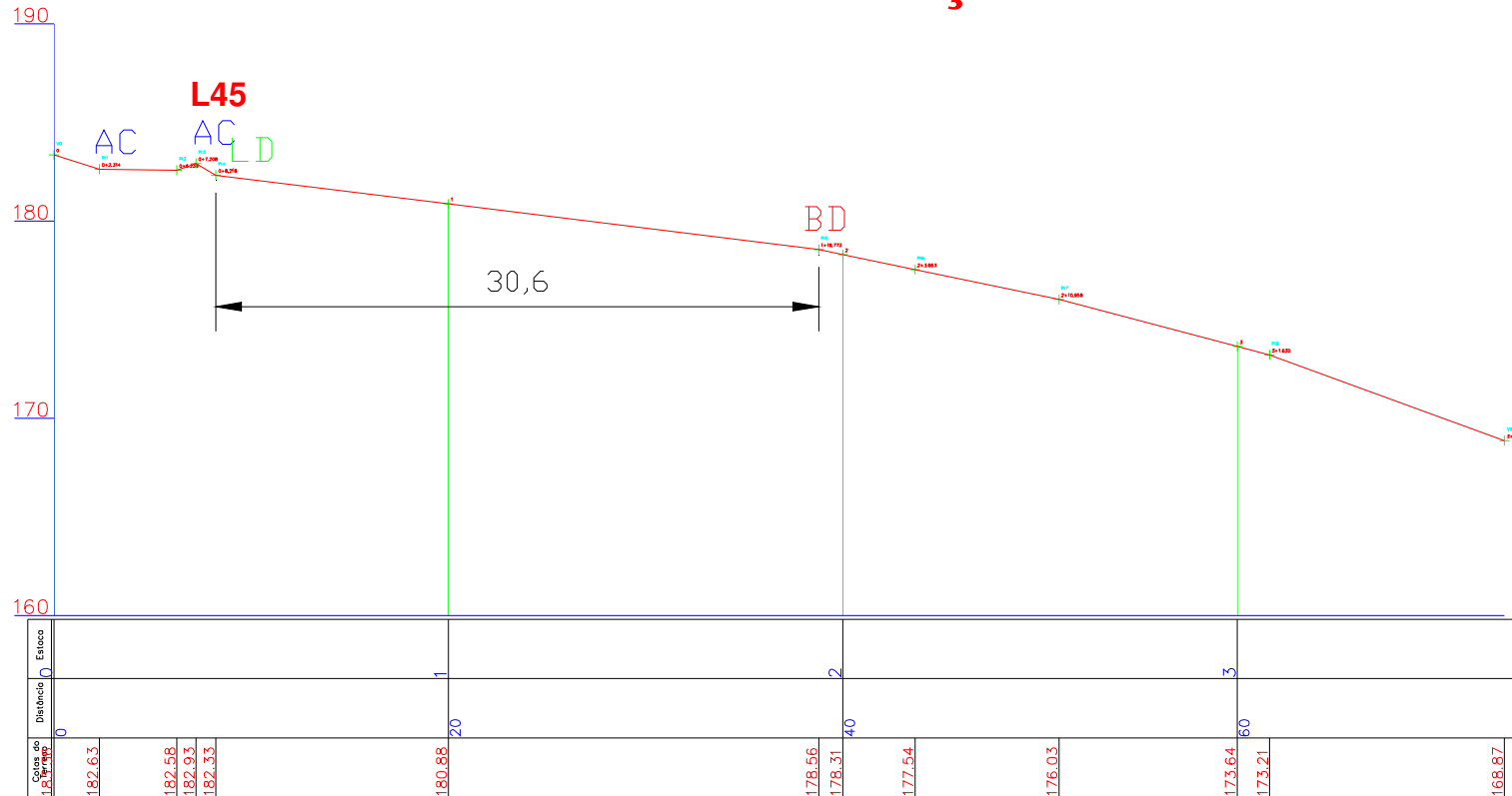

SD - Simite de Desmatamento
 BD - Borda
 AF - AFSoramento
 BX - Bauxita ND - NoduSar
 ST - Saterita

ESCASA 1:200 H 1:200 V

Seção 46 AVN

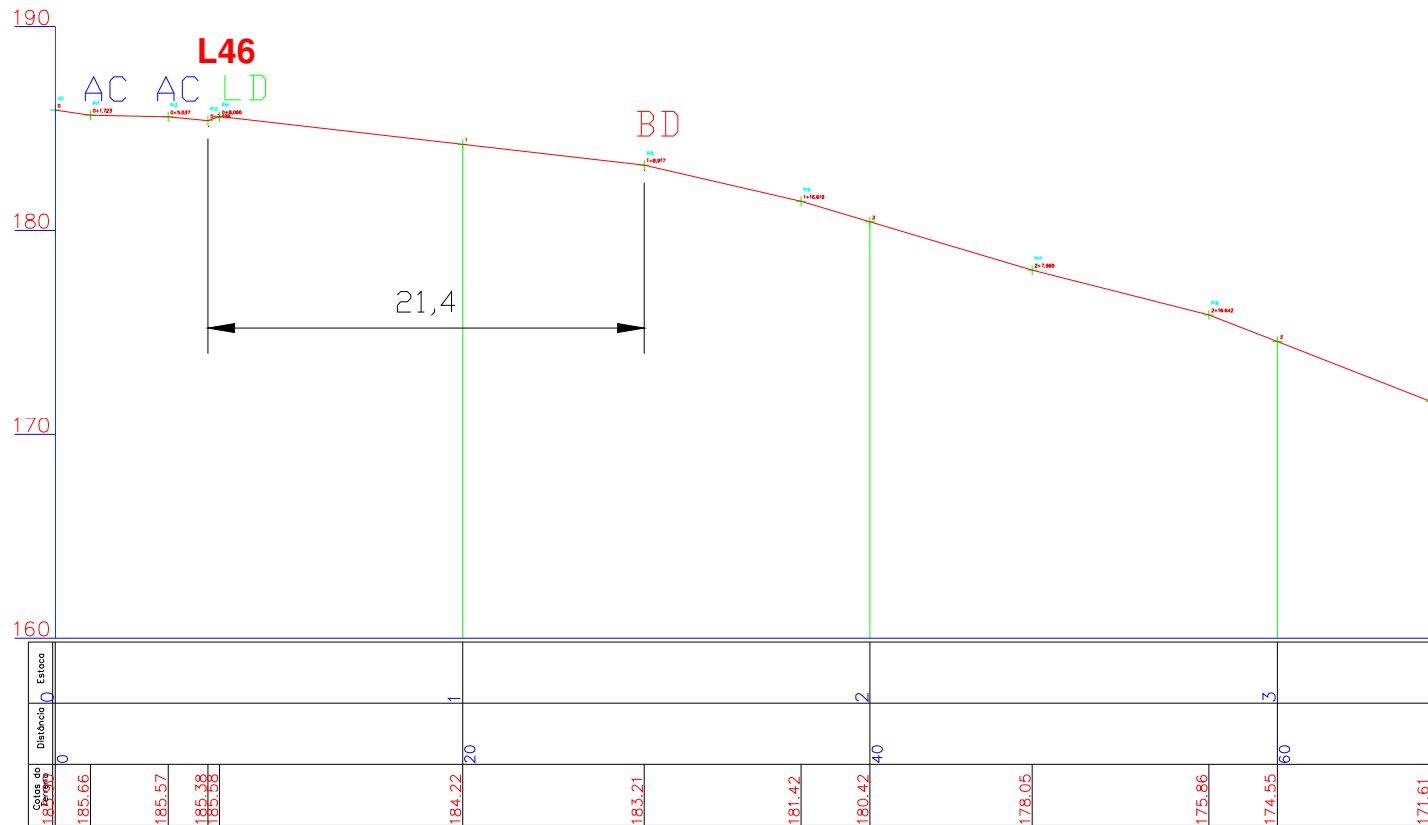

- AC - Acesso
- SD - Simite de Desmatamento
- BD - Borda
- AF - AFSoramento
- BX - Bauxita ND - NoduSar
- ST - Saterita

ESCASA 1:200 H 1:200 V

Seção 47 AVN

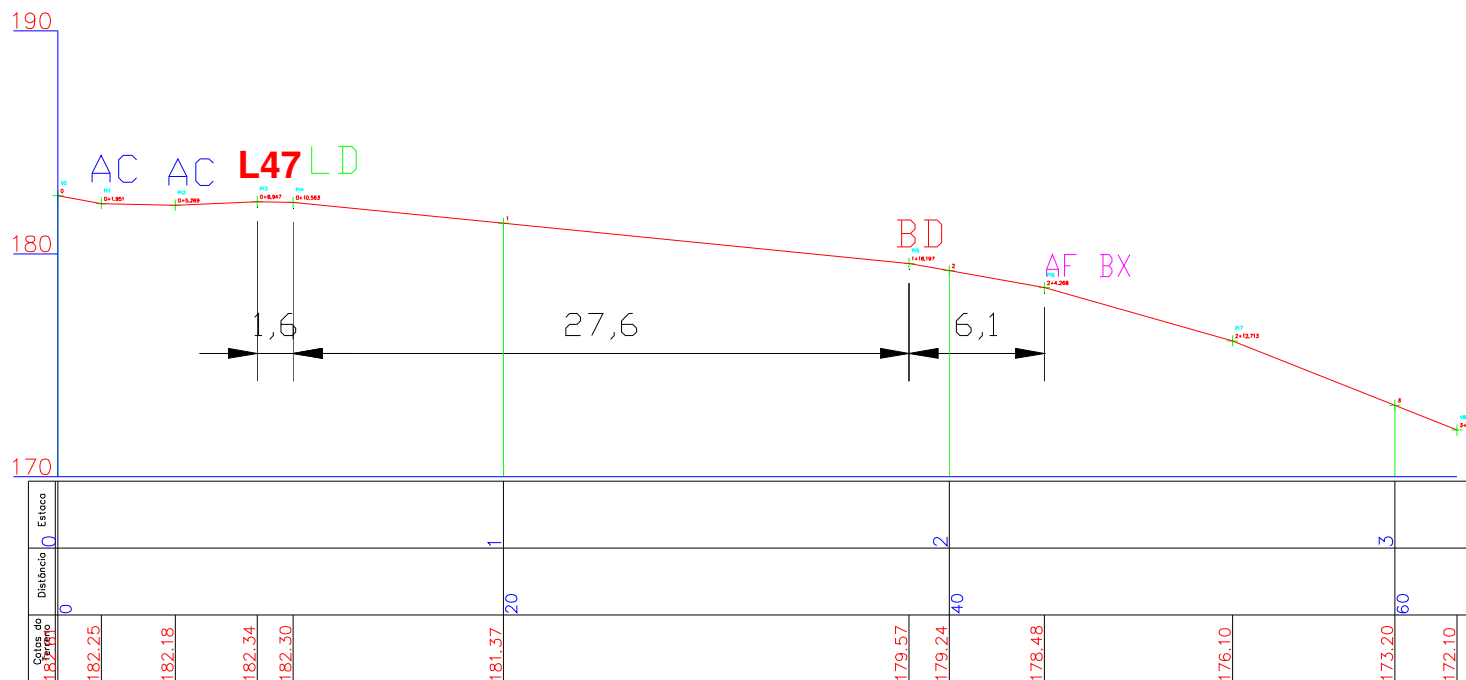

- AC - Acesso
- SD - Simite de Desmatamento
- BD - Borda
- AF - AFSoramento
- BX - Bauxita ND - NoduSar
- ST - Saterita

ESCASA 1:200 H 1:200 V

MINA DO AVISO - OESTE

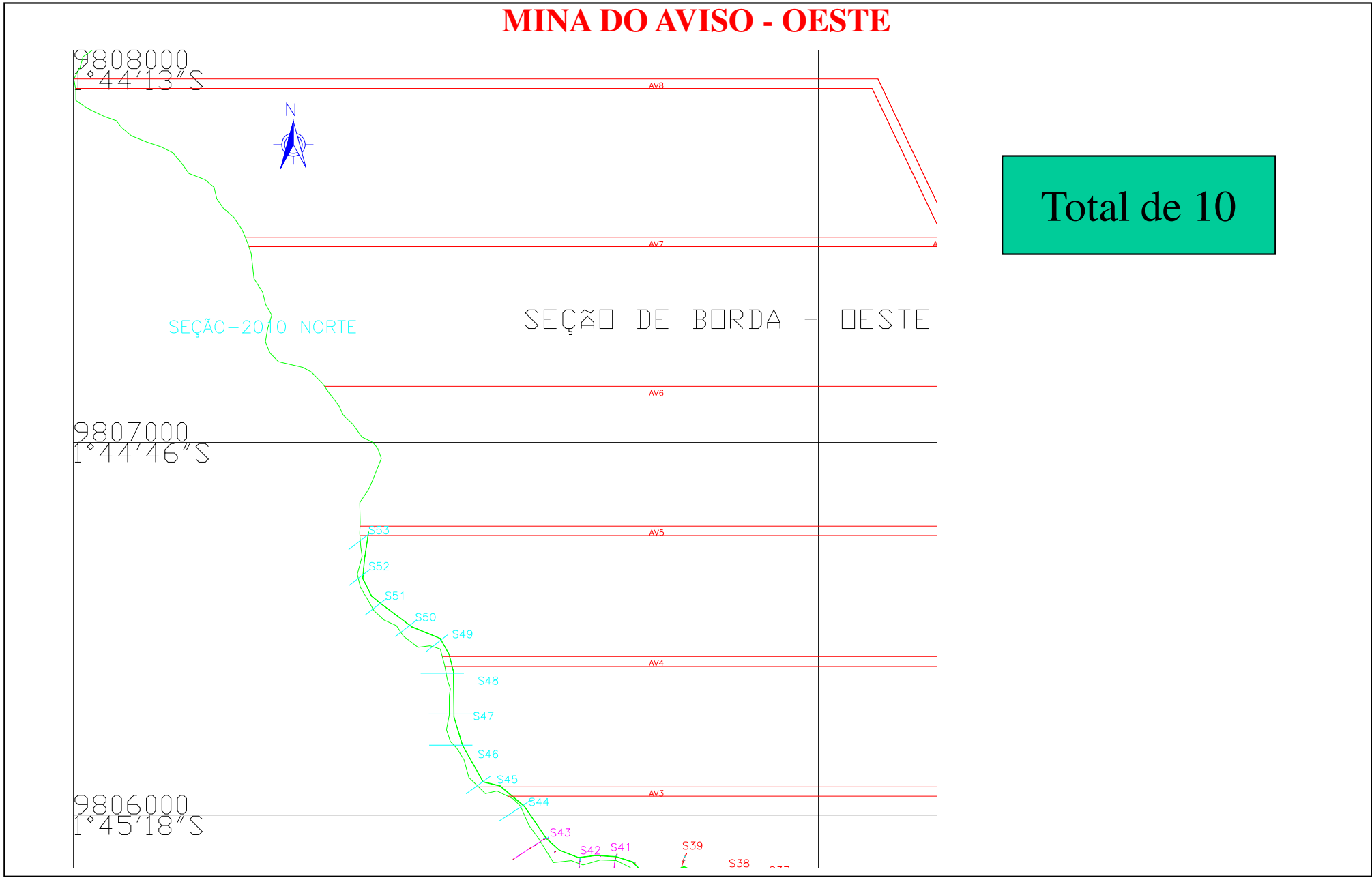

Total de 10



PERFIL LONGITUDINAL SEÇÕES DE BORDAS 2010

Seção 44 AVS

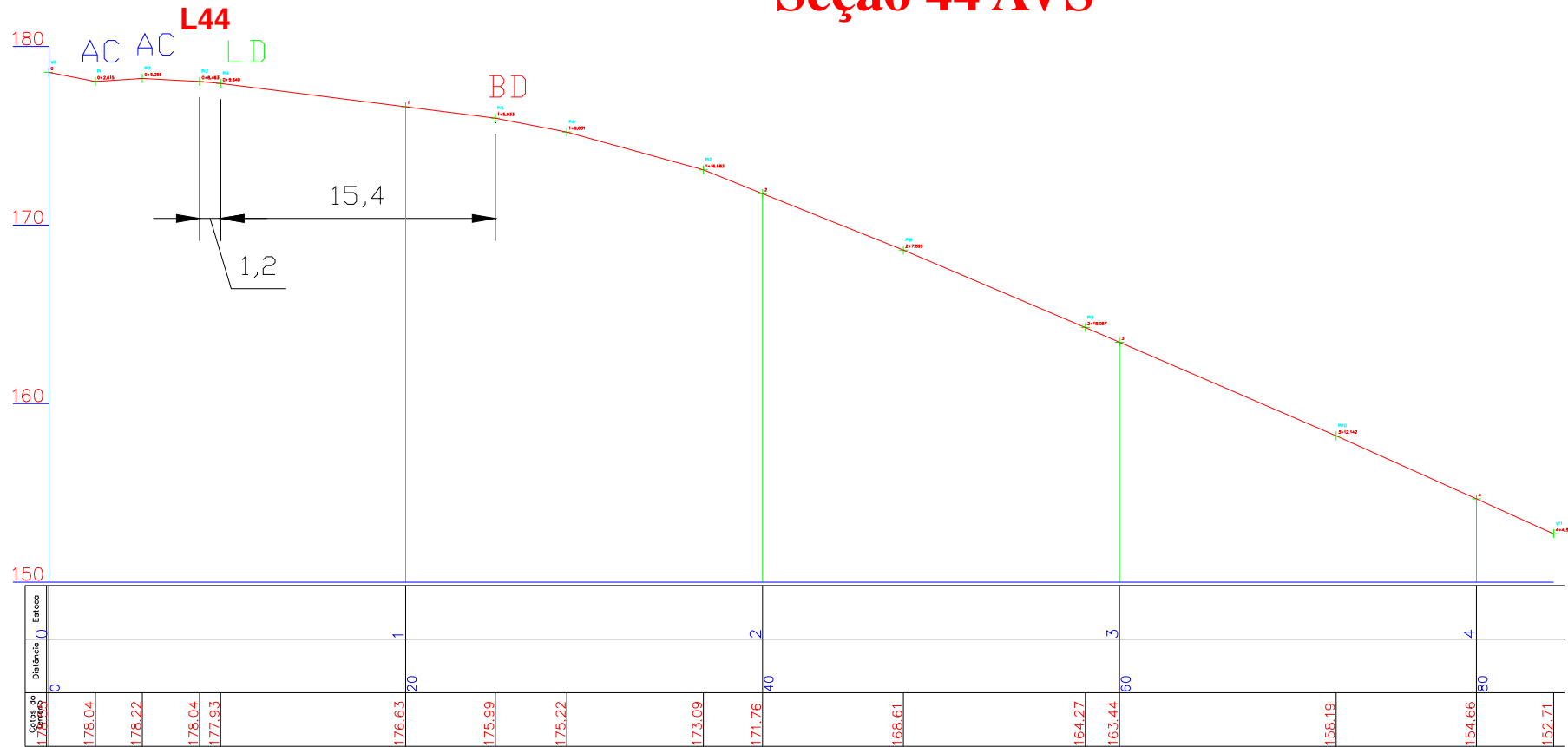

- AC - Acesso
- LD - Limite de Desmatamento
- BD - Borda
- AF - Afloramento
- BX - Bauxita ND - Nodular
- LT - Laterita

ESCALA 1:200 H 1:200 V

Seção 45 AVS

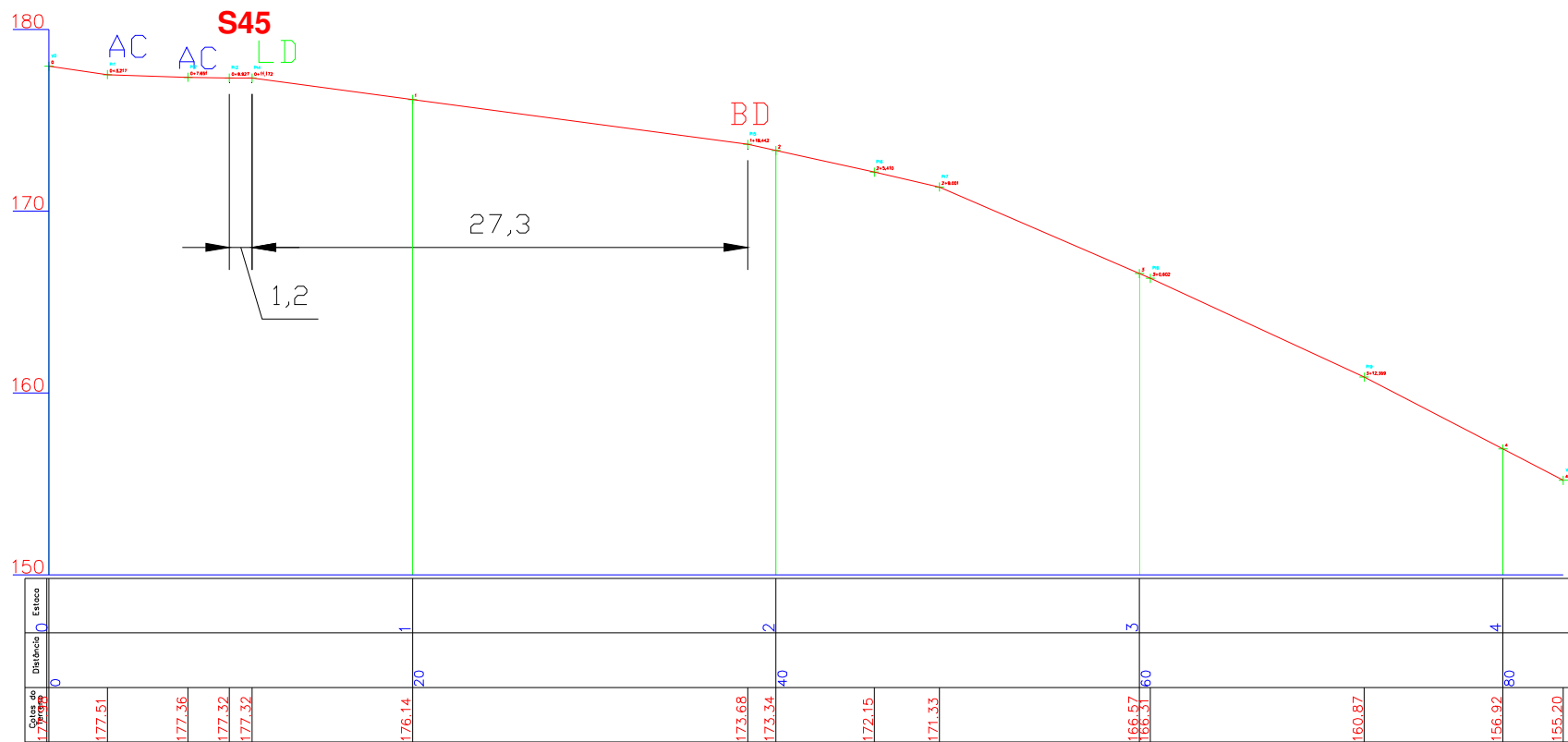

- AC - Acesso
- LD - Limite de Desmatamento
- BD - Borda
- AF - Afloramento
- BX - Bauxita ND - Nodular
- LT - Laterita

ESCALA 1:200 H 1:200 V

Seção 46 AVS

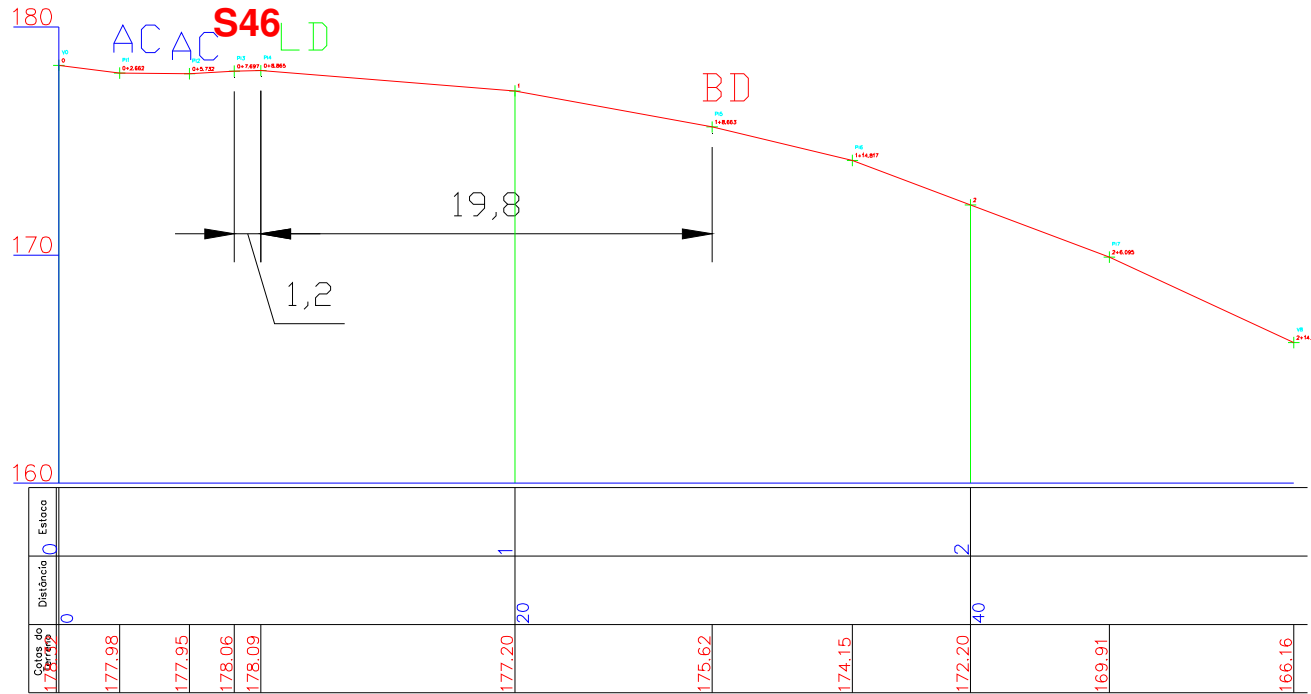

AC - Acesso
 LD - Limite de Desmatamento
 BD - Borda
 AF - Afloramento
 BX - Bauxita ND - Nodular
 LT - Laterita

ESCALA 1:200 H 1:200 V



PERFIL LONGITUDINAL SEÇÕES DE BORDAS 2010

Seção 47 AVS

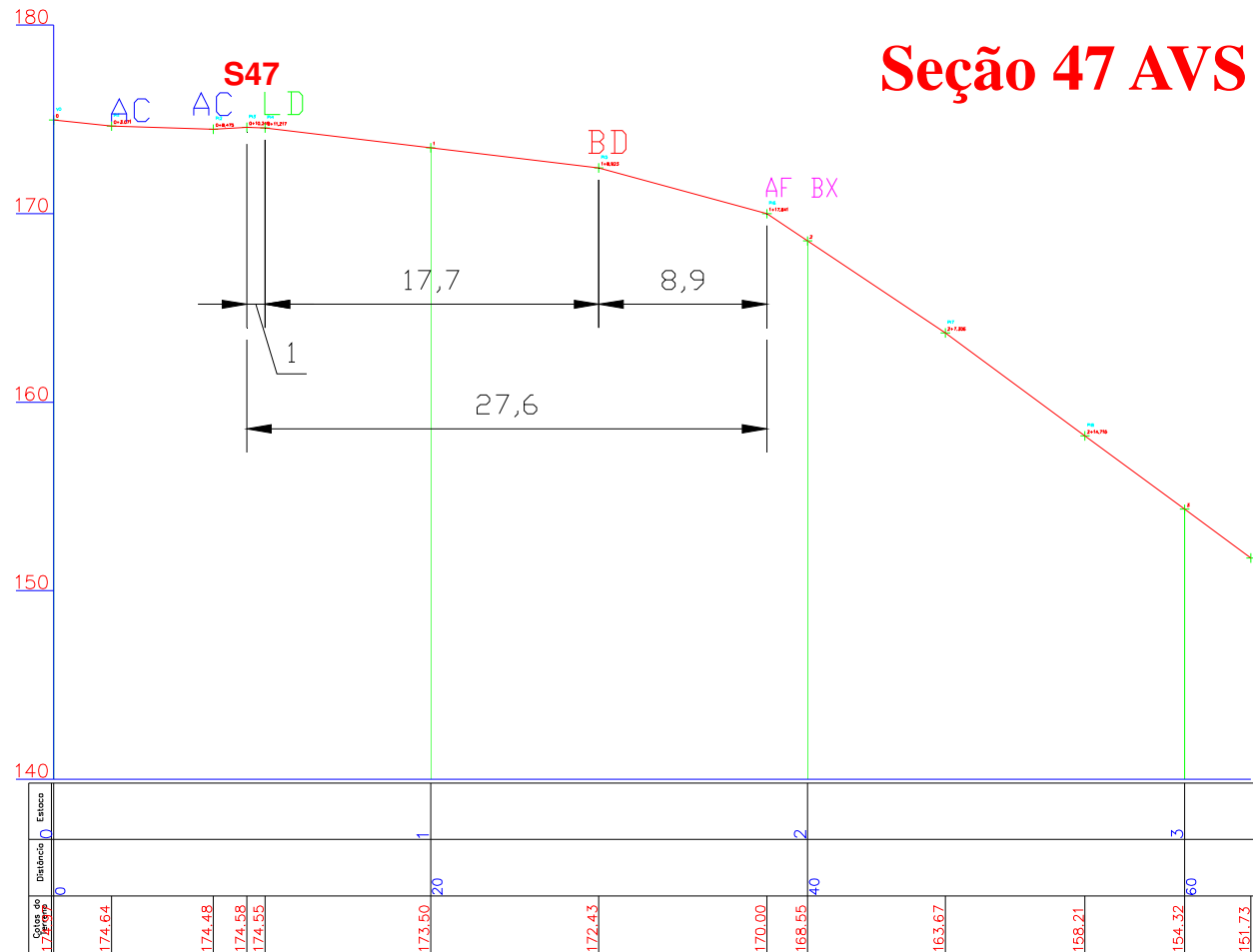

- AC - Acesso
- LD - Limite de Desmatamento
- BD - Borda
- AF - Afloramento
- BX - Bauxita ND - Nodular
- LT - Laterita

ESCALA 1:200 H 1:200 V



PERFIL LONGITUDINAL SEÇÕES DE BORDAS 2010

Seção 48 AVS

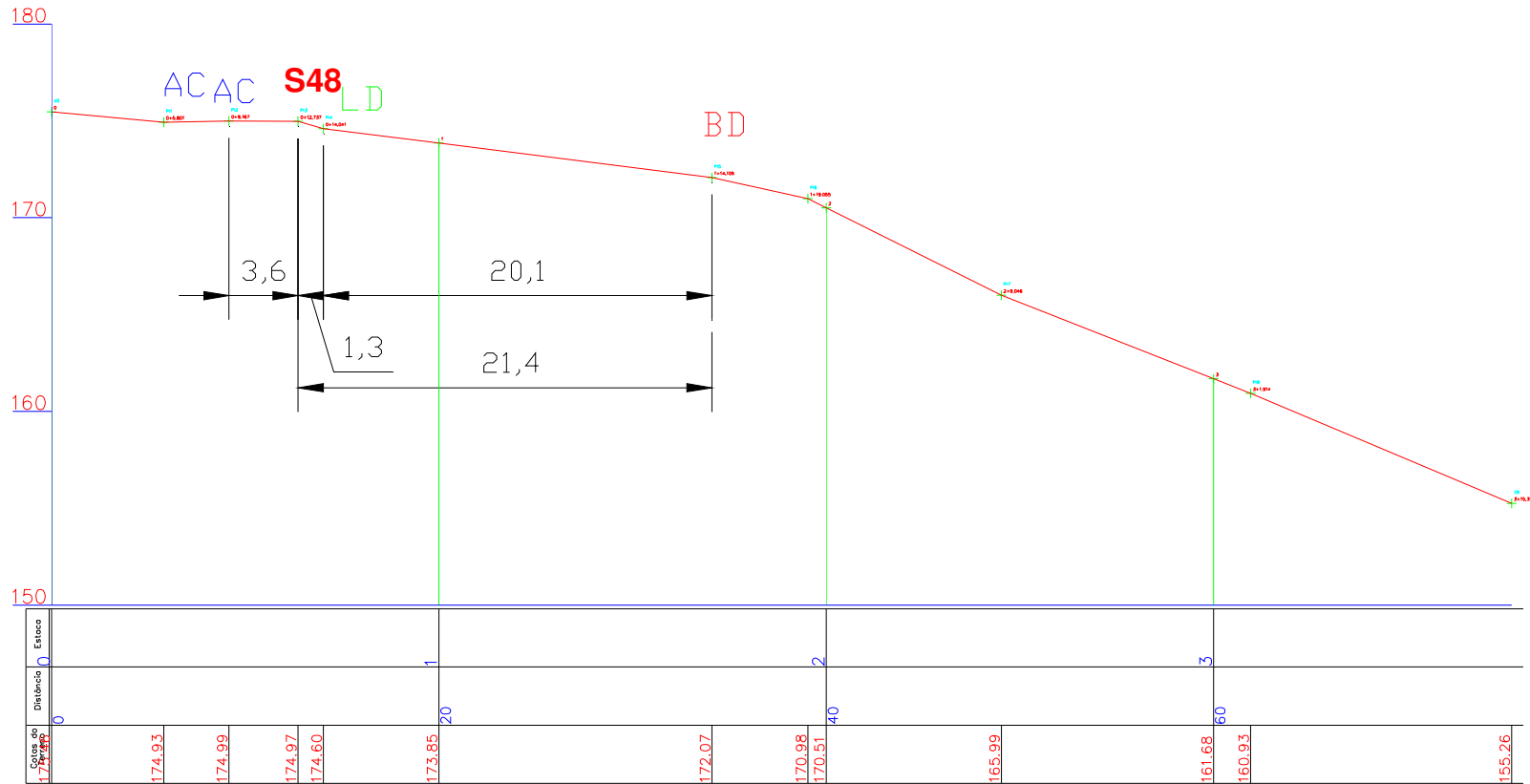

AC - Acesso
LD - Limite de Desmatamento
BD - Borda
AF - Afloramento
BX - Bauxita ND - Nodular
LT - Laterita

ESCALA 1:200 H 1:200 V

Seção 49 AVS

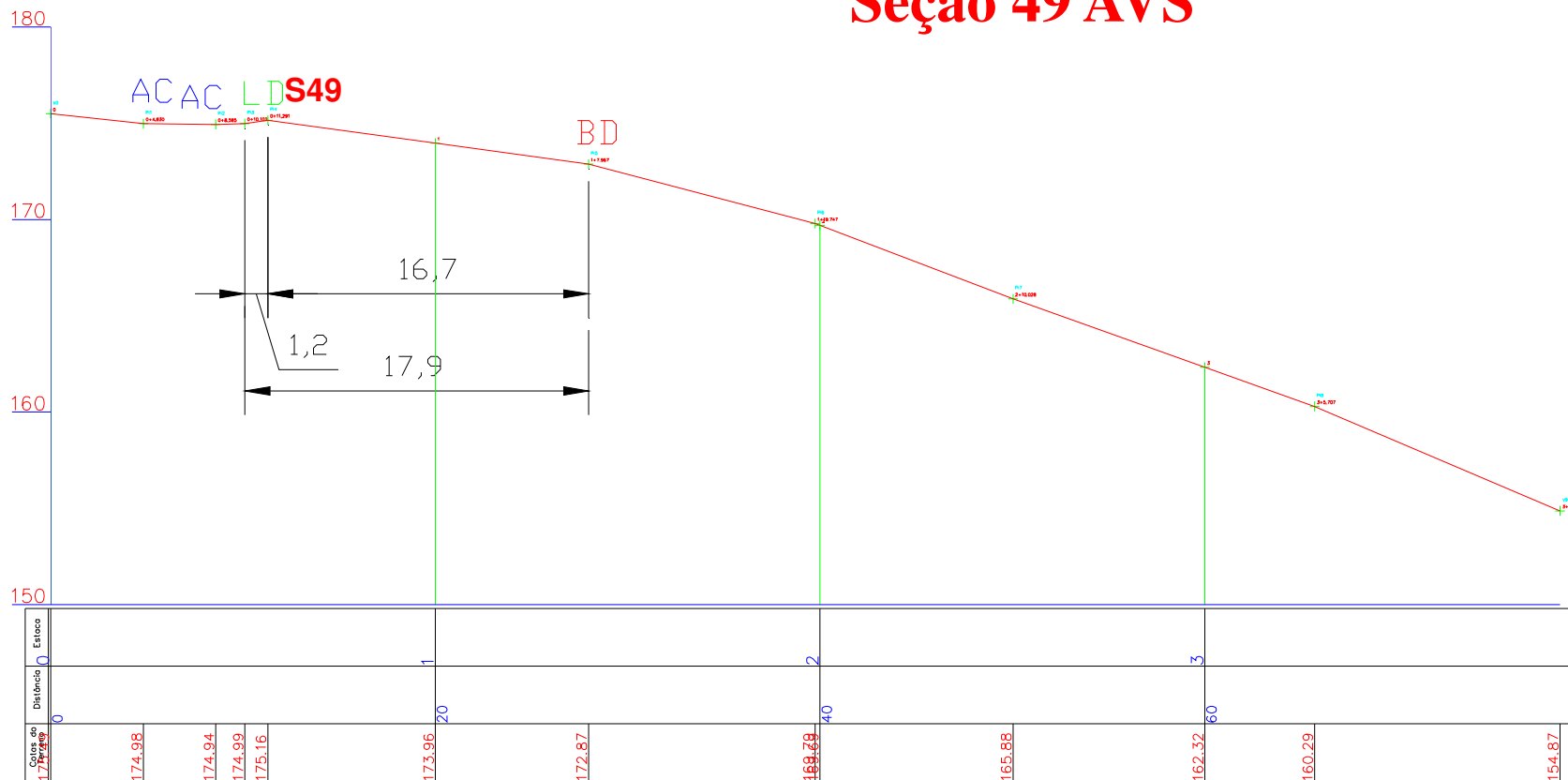

- AC - Acesso
- LD - Limite de Desmatamento
- BD - Borda
- AF - Afloramento
- BX - Bauxita ND - Nodular
- LT - Laterita

ESCALA 1:200 H 1:200 V



PERFIL LONGITUDINAL SEÇÕES DE BORDAS 2010

Seção 50 AVS

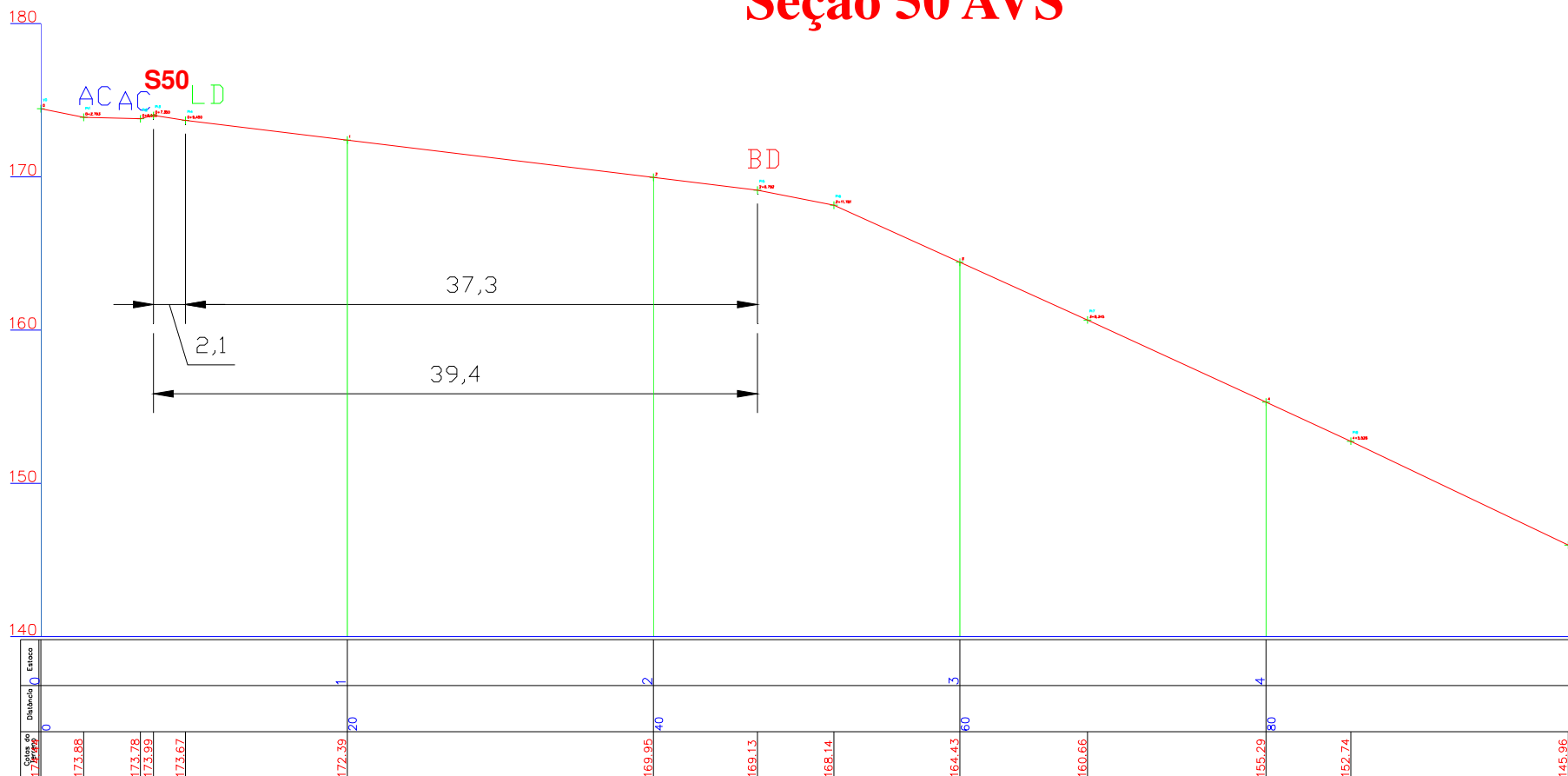

AC - Acesso
LD - Limite de Desmatamento
BD - Borda
AF - Afloramento
BX - Bauxita ND - Nodular
LT - Laterita

ESCALA 1:200 H 1:200 V

Seção 51 AVS

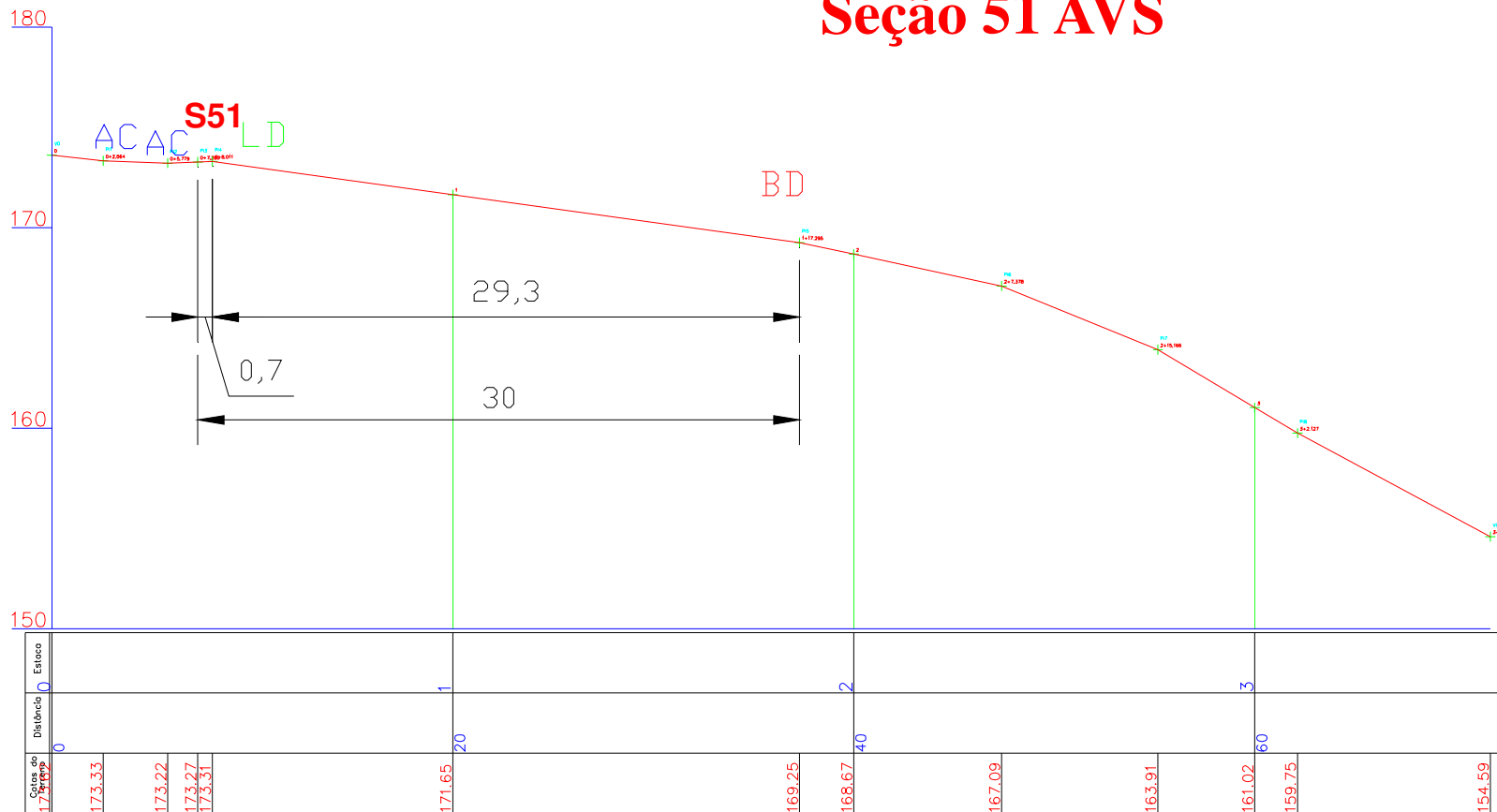

- AC - Acesso
- LD - Limite de Desmatamento
- BD - Borda
- AF - Afloramento
- BX - Bauxita ND - Nodular
- LT - Laterita

ESCALA 1:200 H 1:200 V



PERFIL LONGITUDINAL SEÇÕES DE BORDAS 2010

Seção 52 AVS

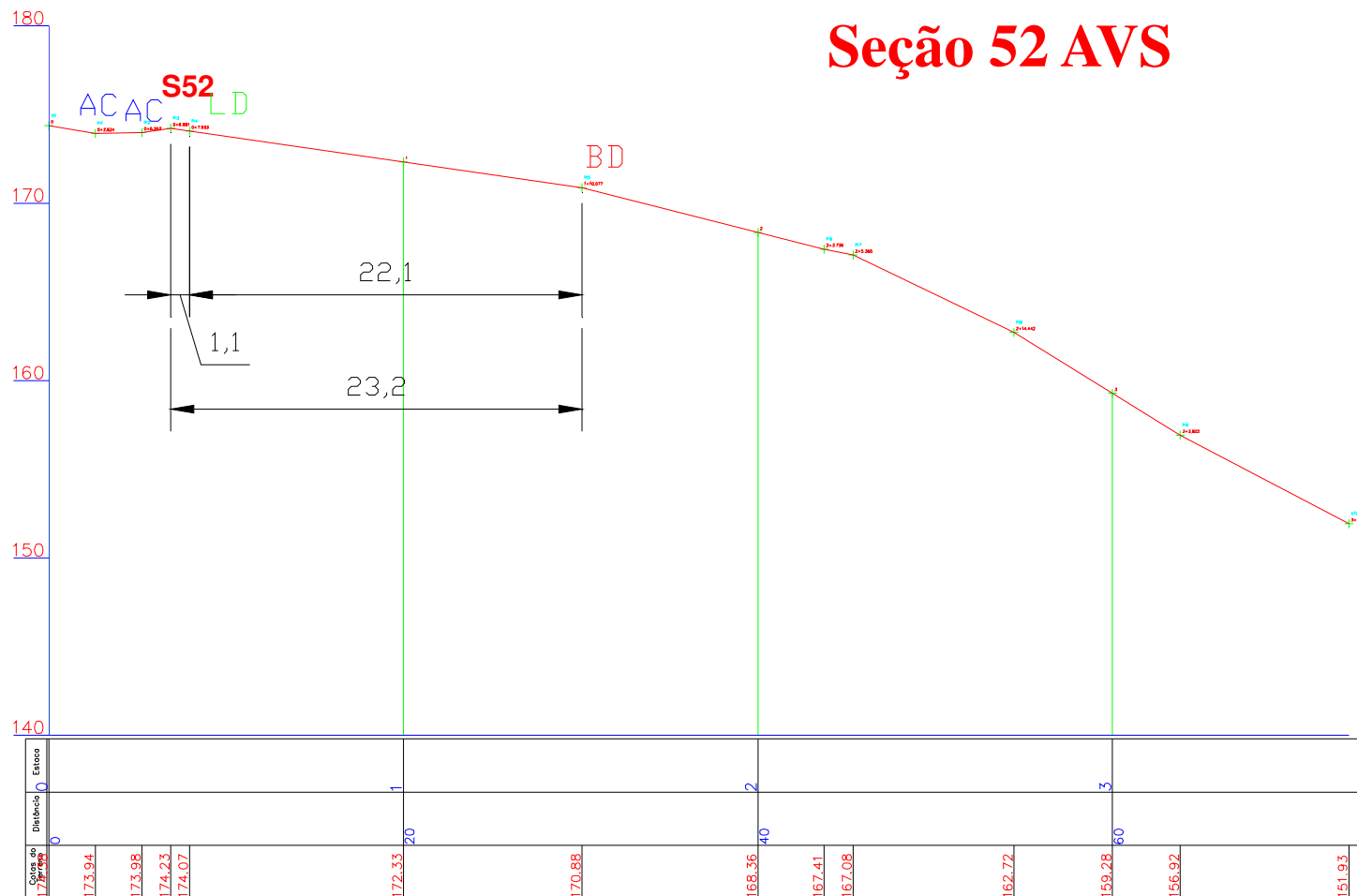

- AC - Acesso
- LD - Limite de Desmatamento
- BD - Borda
- AF - Afloramento
- BX - Bauxita ND - Nodular
- LT - Laterita

ESCALA 1:200 H 1:200 V

Seção 53 AVS

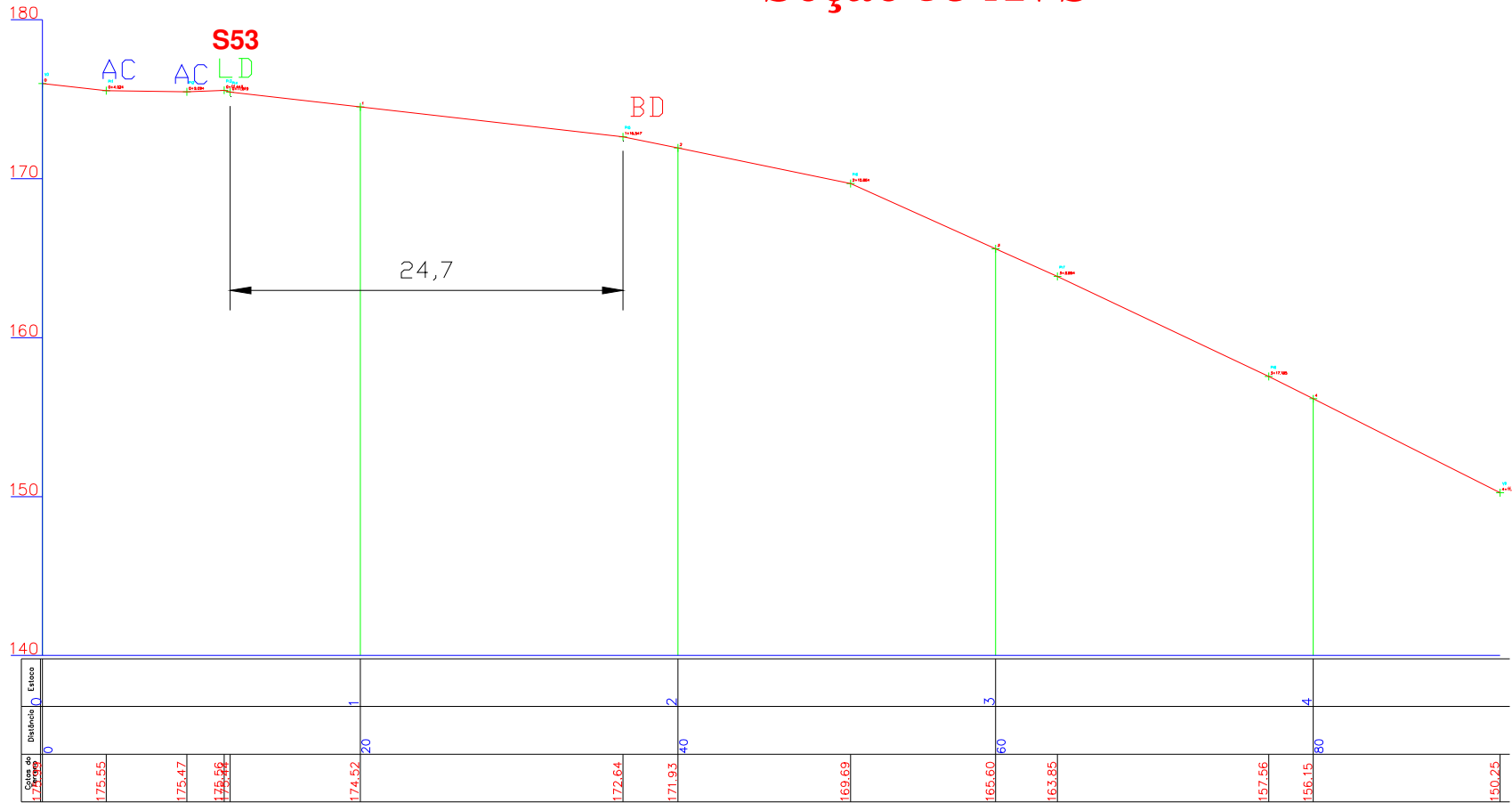

AC - Acesso
 LD - Limite de Desmatamento
 BD - Borda
 AF - Afloramento
 BX - Bauxita ND - Nodular
 LT - Laterita

ESCALA 1:200 H 1:200 V